



2018 PRODUCT CATALOG



ABOUT US

Above All Lighting, a leader in R&D, manufacturing and customization of LED indoor and outdoor light fixtures. Above All Lighting is focused on serving the commercial and industrial markets and a commitment to design and manufacturing excellence. Above All Lighting uses the latest LED, thermal, optical, and control components in our products to ensure the best quality and the technology for the United States and Canadian Market.

Above All Lighting's headquarters is located in Toms River, New Jersey where Above All Lighting's products are engineered, designed and customized in our machine shop. Above All Lighting also owns its 600,000sf ISO9001: 2000 and ISO14001: 2004 certified factory in Asia to ensure the high quality of our products.

Above All Lighting's LED products include: area lights, outdoor floods, high bays, wall packs, garage lights, ceiling lights, LED tubes, and flat panels which meet the latest DLC requirements. Above All Lighting also offers led luminaires with special features such as customization of optics, brackets, diffusers, and controls including smart lighting technology, daylighting, motion and photo sensors, mesh networks, cameras, and Wi-Fi routers.

Above All Lighting's expert staff includes 22 engineers, 6 designers, and a senior management team with most of them having over 20 years of experience serving design, manufacturing, electrical distributors and contractors.

Service to customers and providing the best quality products is Above All Lighting's formula for success.

TABLE OF CONTENTS

EPA 0.7 Glass Lens Moon Series Post Top	P5-6
DLC P Glass Lens V-Line Wall Pack	P7-8
DLC P Architecture Leopard Series Mini Wall Pack	P9-10
Glass Lens Traditional Standard Wall Pack	P11-12
DLC P Glass Lens LED Dark Sky Wall Pack	P13-14
Architecture TR Security Light	P17-18
Traditional Security Light	P19-20
DLC P Glass V-Line Flood Light	P23-24
DLC P Architecture Leopard Series Mini Flood Light	P25-26
Glass Lens Mini Flood Light With 110° Beam Angle	P27-28
DLC P Glass Lens MT Universal Light	P31-34
SMT LED Area Light NEW	P35-38
DLC P Glass Lens Pad Canopy	P41-42
DLC P LS Parking Garage	P43-44
Parking Garage Light	P45-46
DLC P LED Canopy	P47-48
Full optic LED UFO High Bay	P51-52
DLC P LED Linear High Bay	P53-54
Heavenly Linear High Bay NEW	P55-57
PMMA, Samsung LED Chip LED Flat Panel 1'x4'	P59-60
PMMA, Samsung LED Chip LED Flat Panel 2'x2'	P61-62
PMMA, Samsung LED Chip LED Flat Panel 2'x4'	P63-64
DLC P LED Center Basket Troffer	P67-68
DLC P LED Troffer Retrofit Kit 2'x2' DL Series	P69-70
DLC P LED Troffer Retrofit Kit 2'x4' DL Series	P71-72
DLC P LED STD WRAP	P73-74
LED STD Strip	P77-78
Commercial Downlight Retrofit Kit 6 Inch	P79-80
Commercial Downlight Retrofit Kit 6 Inch & 8 Inch	P81-82
T8 LED Quick-Kit 2FT (10W Per Tube)	P83-84
T8 LED Quick-Kit 4FT (15W Per Tube)	P85-86
T8 LED Quick-Kit 4FT (18W Per Tube)	P87-88
LED Compatible T8 Glass Tube	P89-90
LED AC Direct Wire T8 Glass Tube	P91-92
Compatible T5 Tube (Glass)	P93-94





■ **FEATURES**

1. EPA is 0.7Sq.Ft.
2. Tempered Glass Lens
3. Full Lighting Distributions
4. Special Reflector Design

■ **Performance**

Input Watts (LM-79 Reported)	35	47.8	72.1	99.4
Input Voltage	120-277	120-277	120-277	120-277
Output Lumens (@5000K)	4039	5319	8057.4	11595
Replaces (MH)	150W	175W	250W	320W
Lumen Per Watt	115	111	111.8	116.7
BUG Rating	MPT35301-III B2-U1-G1	MPT50301-III B2-U2-G1	MPT75301-V B3-U2-G2	MPT100301-V B3-U2-G2
EPA	0.7 ft ²	0.7 ft ²	0.7 ft ²	0.7 ft ²
Color Accuracy (CRI)	>70	>70	>70	>70
Working Temperature	-40-104°F (-40-40°C)	-40-104°F (-40-40°C)	-40-104°F (-40-40°C)	-40-104°F (-40-40°C)
IP Rating	IP66 rated	IP66 rated	IP66 rated	IP66 rated

■ **Dimensions & Weight**

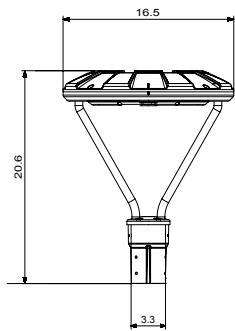

Length: 16.5"
 Width: 16.5"
 Height: 20.6"
 Max. Weight: 16.54 lbs

■ **Ordering Information**

Example: MPT35501-MS-L3B-P1-V

Moon Series	Watts	CCT	Voltage	Controls	Installation	Distribution	Finish
MPT	35 - 35 Watts	30 - 3000K	1 - 120-277V	MS - L3B - Motion Sensor	P1 - 2 3/8" or 3"	V - Type V	Blank - Dark
	50 - 50 Watts	40 - 4000K	2 - 347V¹	With Black L3 Lens ⁴	Tenon pole ⁶	III - Type III	Bronze
	75 - 75 Watts	50 - 5000K	3 - 480V²	MS - L7B - Motion Sensor		II - Type II	AL - Aluminum
	100 - 100 Watts		6 - 347/480V³	with Black L7 Lens ⁴			Silver
				PC - Photoelectric Control			
				7P - 7-Pin PE Receptacle ⁵			

Notes:

1. 347V is only used with photoelectric control.
2. 480V is only used with photoelectric control.
3. If choose 347/480V, please do not choose photoelectric control. 347/480V is not available for 35W.

4. Black L3 lens is standard for 35W and 50W; Black L7 lens is standard for 75W and 100W. Please check the motion sensor manual for more information.
5. Shorting cap included.
6. 4"OD round pole adapter is available for accessory.

*Please Ask Customer Service for any special requests.

EPA 0.7 Glass Lens Moon Series Post Top

■ Accessories Information (Order Separately)



MPT-4RPA

4"OD round pole adapter for Moon series post top



MPT-HSS

House side shield for Moon series post top

■ Application

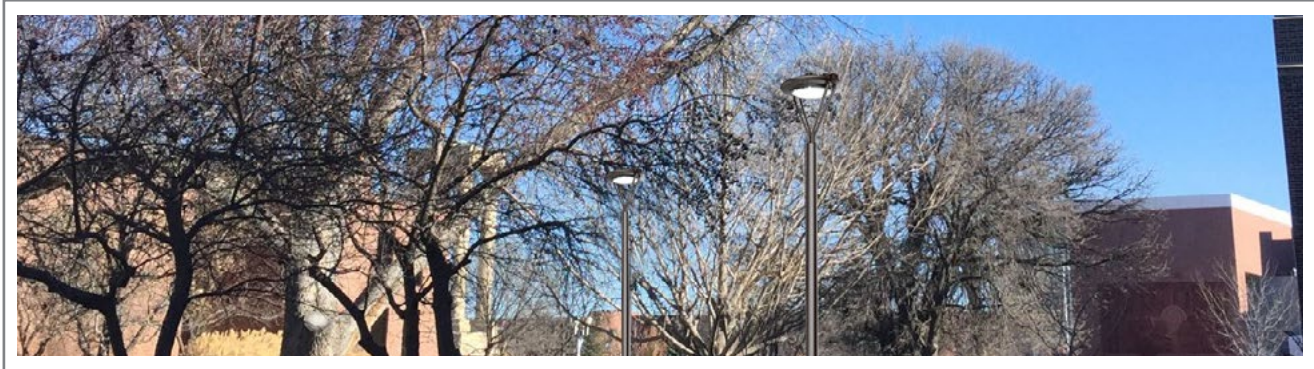

■ Photometry

Mounting Height	16.5	19.8	23.1	26.4	29.7	33	36.3	39.6	42.9	46.2	49.5	52.8	66
Multiplier	16.0	11.1	8.2	6.3	4.9	4.0	3.3	2.8	2.4	2.0	1.8	1.6	1

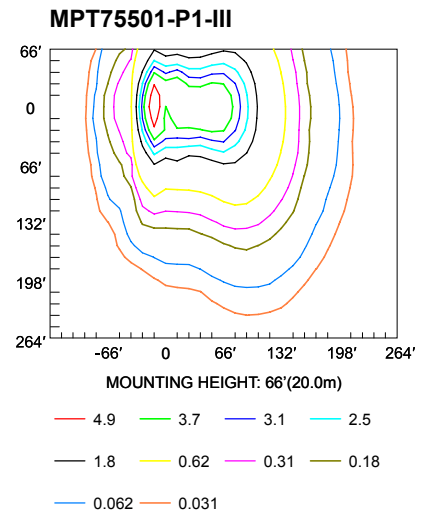
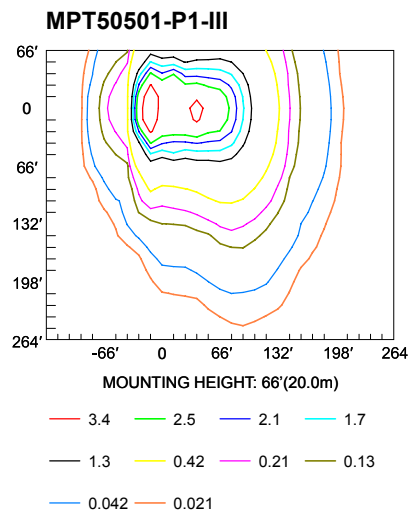
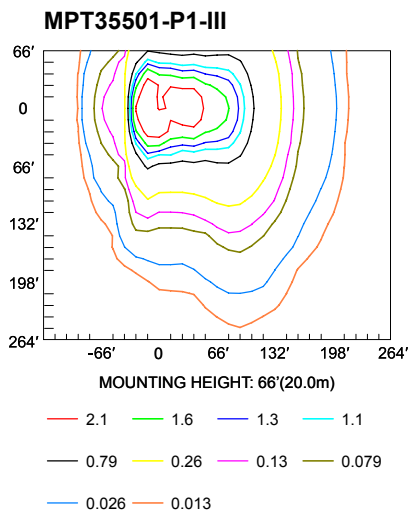

Note: Please visit our website for more details.





■ **FEATURES**

1. Top 5 LED Chip & LED Driver
2. Tempered Glass Lens
3. EBU Available For Low Wattage
4. 3000-14,000 Lumen Package

■ **Performance**

Input Watts (LM-79 Reported)	25	41	52	81	101	123
Input Voltage	120-277	120-277	120-277	120-277	120-277	120-277
Output Lumens (@5000K)	3060	4960	6548	10166	12558	14454
Replaces (MH)	150W	175W	250W	320W	400W	400W
Lumen Per Watt	123	121	127	125	124	117
Color Accuracy (CRI)	>70	>70	>70	>70	>70	>70
Bug Rating	B1-U1-G1	B2-U1-G1	B1-U1-G1	B2-U1-G2	B3-U1-G2	B3-U2-G2
EPA	26W/38W EPA= 0.68 max (depending on mounting type)		52W/80W/100W/120W EPA=1.42 max (depending on mounting type)			
Working Temperature	-40-104°F (-40-40°C)			-40-104°F (-40-40°C)		
IP Rating	IP65 rated				IP65 rated	

■ **Installation**

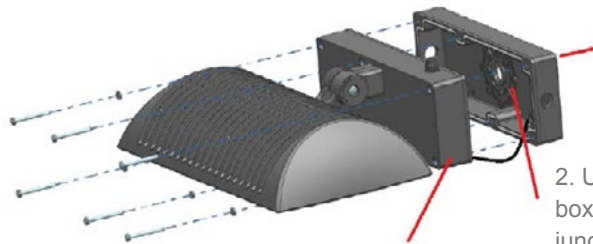

1. Put Driver box (Water proof foam at back) to appropriate position, follow installation manual.

2. Using tool to open holes at driver box (The holes position in driver box follow U.S. standard the hole position of appropriate position junction box requirement), screw tightly.

3. Closed power supply cover, screw tightly and finish installation.

■ **Dimensions & Weight**

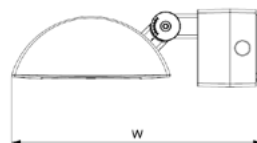
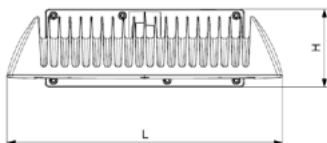

Without EBU and Motion Sensor

26W & 38W

Length: 10.12"
Width: 9.84"
Height: 4.69"
Max. Weight: 8.8 lbs

52W, 80W, 100W, 120W

Length: 15.32"
Width: 13.78"
Height: 4.44"
Max. Weight: 17 lbs

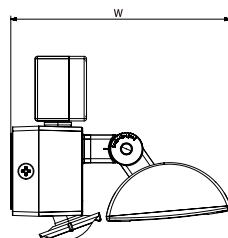
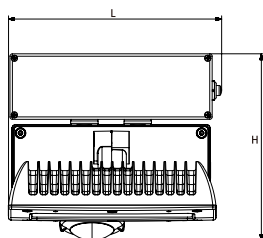

With EBU and Motion Sensor

26W & 38W

Length: 10.35"
Width: 10.83"
Height: 9.24"
Max. Weight: 11.92 lbs

Ordering Information Example: WL26501

Wall Light	Watts	CCT	Voltage	Controls	Lens Type
WL	26 - 26 Watts	30 - 3000K ¹	1 - 120-277V	MS - Multi Level Motion Sensor ²	L3B - Black L3 lens ⁵
	38 - 38 Watts	40 - 4000K	4 - 120V	PC - Photo Control ³	
	52 - 52 Watts	50 - 5000K	5 - 277V	EBU - Emergency battery backup ⁴	
	70 - 80 Watts		6 - 347V/ 480V ⁶		
	100 - 100 Watts				
	120 - 120 Watts				

Notice:

- 3000K DLC Premium only qualified in 26W, 38W, 52W and 80W
- Motion Sensor is only available in 26W and 38W
- PC is only for 120V or 277V. Without PC, please choose 120-277V
- EBU is only available in 26W and 38W. And, the working temperature is 0-40°C
- Default motion sensor lens type is black L3 lens - Please ask customer service for other options.
- High Voltage version is unavailable in 26W and 38W.

* Standard Finish as Dark Bronze. Special Order as other finish color - Please Ask Customer Service for Details.

Photometry

Mounting Height	10	12	15	18	20	25	33
Multiplier	10.9	7.6	4.9	3.4	2.8	1.8	1

All published luminaire photometric testing performed to IESNA LM-79-08 standards by a NVLAP certified laboratory.

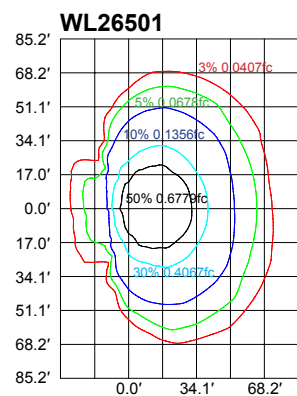

MOUNTING HEIGHT: 33'(10.0m)

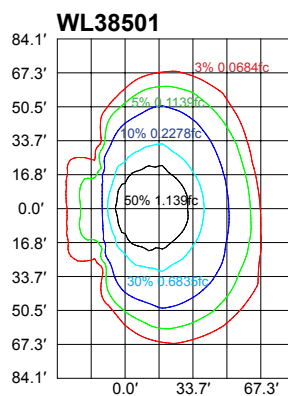

MOUNTING HEIGHT: 33'(10.0m)

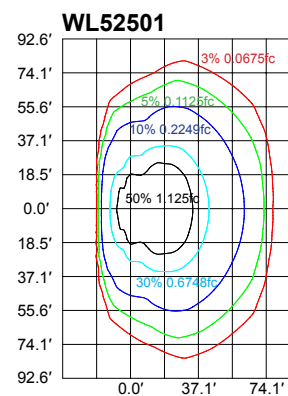

MOUNTING HEIGHT: 33'(10.0m)

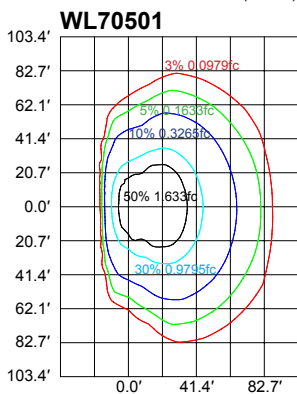

MOUNTING HEIGHT: 33'(10.0m)

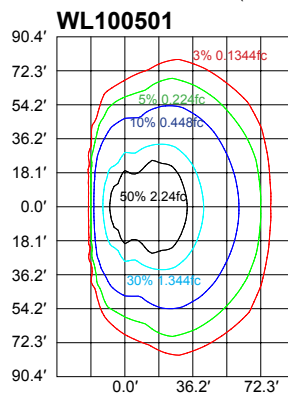

MOUNTING HEIGHT: 33'(10.0m)

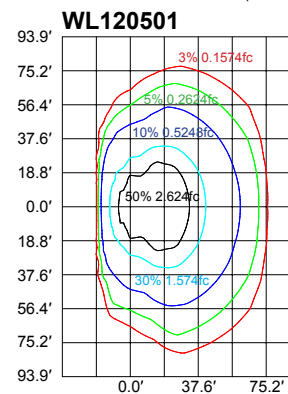

MOUNTING HEIGHT: 33'(10.0m)

Note: Please visit our website for more details.





■ **FEATURES**

1. Top 5 LED Chip
2. Modern Yet Classic Design
3. Versatile Design

■ **Performance**

Input Watts (LM-79 Reported)	14	20
Input Voltage	120-277	120-277
Output Lumens (@5000K)	1626	2275
Replaces (MH)	70W	100W
Lumen Per Watt	115	114
Color Accuracy (CRI)	>70	>70
Bug Rating	B1-U1-G0	B1-U1-G0
Working Temperature	-40-104°F (-40-40°C)	-40-104°F (-40-40°C)
IP Rating	IP65 rated	IP65 rated

■ **Installation**



Wall Pack, Wall Mount,
Including junction box



Connection between junction box
and fixture can be adjusted

■ **Dimensions**

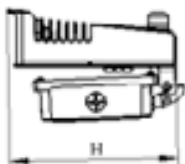

**15W&20W wall mount
(with junction box)**

Length: 7.2"

Width: 5.6"

Height: 4.8"

■ Ordering Information

Example: MFW15504-PC-WL

Mini Flood and Wall Light	Watts	CCT	Voltage	Controls	Installation
MFW	15 - 15 Watts	30 - 3000K	1 - 120-277V	PC - Photo Control ² (only 120V or 277V)	WL - Wall Mount(Junction Box)
	20 - 20 Watts	40 - 4000K	4 - 120V		
		50 - 5000K ¹	5 - 277V		

Notice:

1. Only 5000K is qualified with DLC Premium.

2. PC is only for 120V or 277V. Without PC, please choose 120-277V.

* Standard Finish as Dark Bronze. Special Order as other finish color - Please Ask Customer Service for Details.

■ Photometry

All published luminaire photometric testing performed to IESNA LM-79-08 standards by a NVLAP certified laboratory.

Mounting Height	10	12	15	18	20	25	33
Multiplier	10.9	7.6	4.9	3.4	2.8	1.8	1

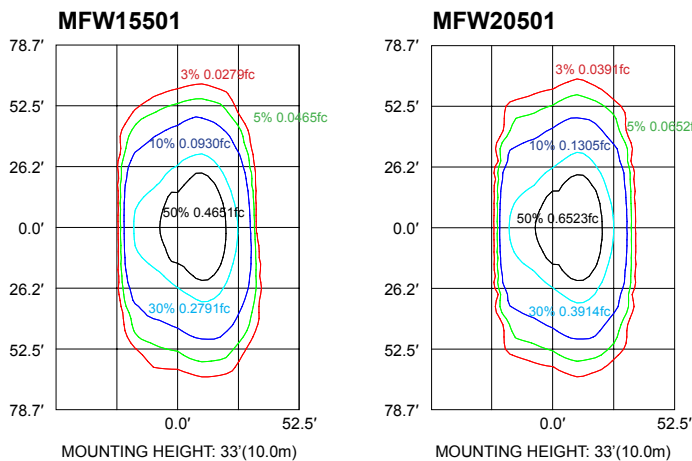

Note: Please visit our website for more details.





■ **FEATURES**

1. Tempered Glass Lens
2. Top 5 LED Chip & LED Driver
3. EBU Available For Low Wattager

■ **Performance**

Input Watts (LM-79 Reported)	21	31	37	50
Input Voltage	120-277	120-277	120-277	120-277
Output Lumens (@5000K)	2385	3269	3663	4941
Replaces (MH)	125W	150W	175W	250W
Lumen Per Watt	114	105	99	99
Color Accuracy (CRI)	>80	>80	>70	>70
Working Temperature	-40-104°F (-40-40°C)	-40-104°F (-40-40°C)	-40-104°F (-40-40°C)	-40-104°F (-40-40°C)
IP Rating	IP65 rated	IP65 rated	IP65 rated	IP65 rated

■ **Dimensions & Weight**

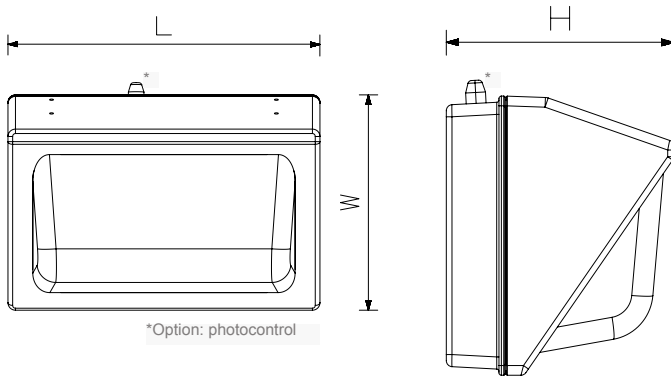

20W & 30W

Length: 14.5"
Width: 9.0"
Height: 7.5"
Max. Weight: 10.12 lbs

40W & 52W

Length: 18.5"
Width: 9.0"
Height: 9.5"
Max. Weight: 16.7 lbs

■ **Ordering Information**

Example: ABBWP30504-PC

ABOVE ALL	Wall Pack	Watts	CCT	Voltage	Controls
ABB	WP	20 - 20 Watts	30 - 3000K ¹	1 - 120-277V	MSW - Microwave Motion Sensor
		30 - 30 Watts	40 - 4000K ²	4 - 120V	PC - Photo Control ³
		40 - 40 Watts	50 - 5000K	5 - 277V	Leave blank for no controls
		55 - 52 Watts			EBU - Emergency Battery Backup ⁴

Notice:

1. 3000K DLC is only available in 20W and 30W.
2. 4000K DLC is only available in 20W and 30W.
3. PC is only for 120V or 277V. Without PC, please choose 120-277V.
4. EBU solution are only available in 20W, 30W and 40W. And the working temperature is 32-104°F.

* Standard Finish as Dark Bronze. Special Order as other finish color - Please Ask Customer Service for Details.

■ Photometry

All published luminaire photometric testing performed to IESNA LM-79-08 standards by a NVLAP certified laboratory.

Mounting Height	10	12	15	18	20	25	33
Multiplier	10.9	7.6	4.9	3.4	2.8	1.8	1

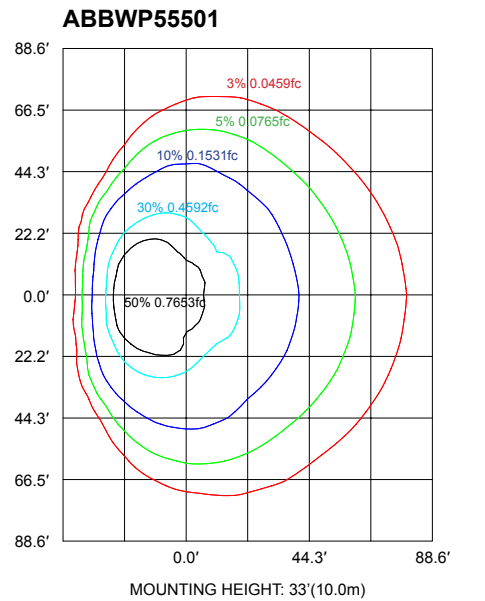
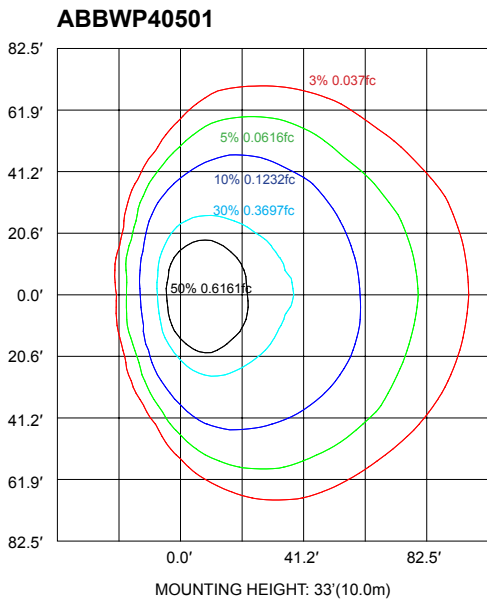
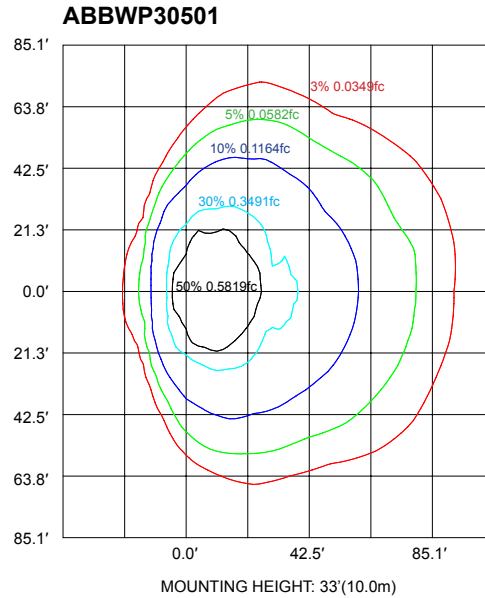
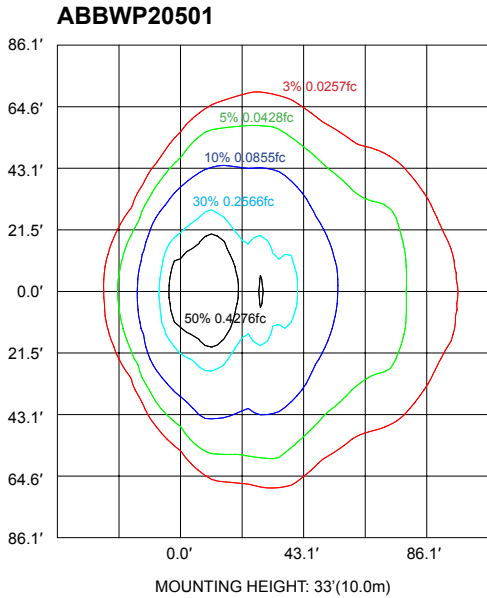

Note: Please visit our website for more details.





■ **FEATURES**

1. DLC Premium listed
2. Imported Long-life LG LED and reliable Fulham driver
3. Uniform color consistency
4. Constructed of tempered glass lens and heavy duty IP65-rated housing
5. No heavy metals or harmful gas
6. Universal voltage
7. Optional photo control, motion sensor and emergency battery backup.

■ **Performance**

Input Watts (LM-79 Reported)	19	29	35	49
Input Voltage	120-277	120-277	120-277	120-277
Output Lumens (@4000K)	2061	3440	4203	6263
Replaces (MH)	125W	150W	175W	250W
Lumen Per Watt	107	120	119	129
Color Accuracy (CRI)	>70	>70	>70	>70
Working Temperature	-31-104°F (-35-40°C)	-31-104°F (-35-40°C)	-31-104°F (-35-40°C)	-31-104°F (-35-40°C)
IP Rating	IP65 rated	IP65 rated	IP65 rated	IP65 rated

■ **Dimensions & Weight**

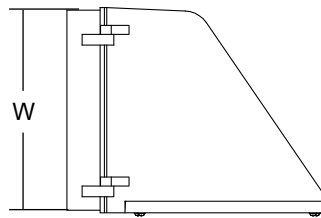
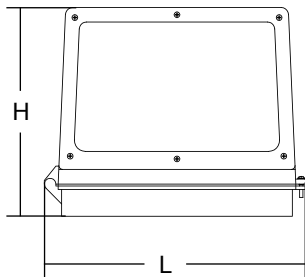

20W, 30W & 38W

Length: 14.4"
Width: 9"
Height: 11.4"
Max. Weight: 9 lbs

52W

Length: 18"
Width: 9.5"
Height: 13.5"
Max. Weight: 15.4 lbs

■ **Ordering Information**

Example: ABWP40LED50DS-MSW

ABOVE ALL	Wall Pack	Watts	Source type	CCT	Distribution	Controls
AB	WP	20 - 20 Watts	LED	30 - 3000K ¹	DS - Dark Sky	MSW - Microware Motion Sensor
		30 - 30 Watts		40 - 4000K		PC12 - Photo Control 120V
		40 - 38 Watts		50 - 5000K		PC27 - Photo Control 277V
		60 - 52 Watts				EBU6 - 6W Emergency battery Backup ²
						Leave blank for no controls

Notice:

1. DLC Premium is unavailable in 3000K.
 2. EBU solution is only available in 20W, 30W and 38W. And the working temperature is 32-104°F.
 3. Special Order as other finish color - Ask Customer Service for Details.
- * Standard Finish as Dark Bronze. Special Order as other finish color - Please Ask Customer Service for Details.

■ Photometry

All published luminaire photometric testing performed to IESNA LM-79-08 standards by a NVLAP certified laboratory.

Mounting Height	10	12	15	18	20	25	33
Multiplier	10.9	7.6	4.9	3.4	2.8	1.8	1

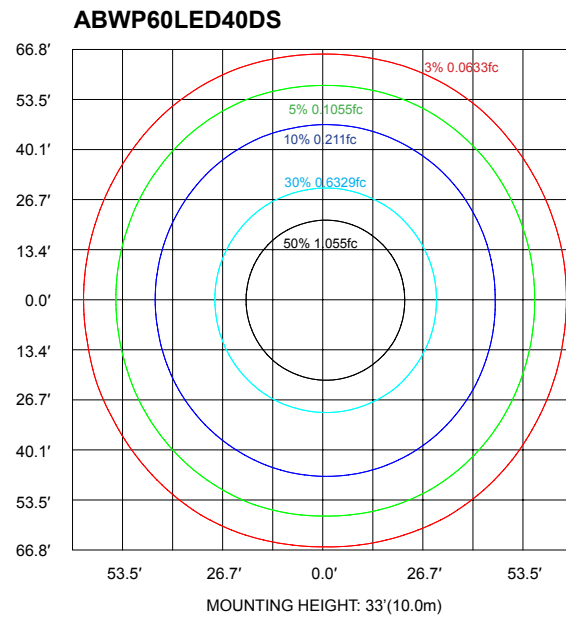
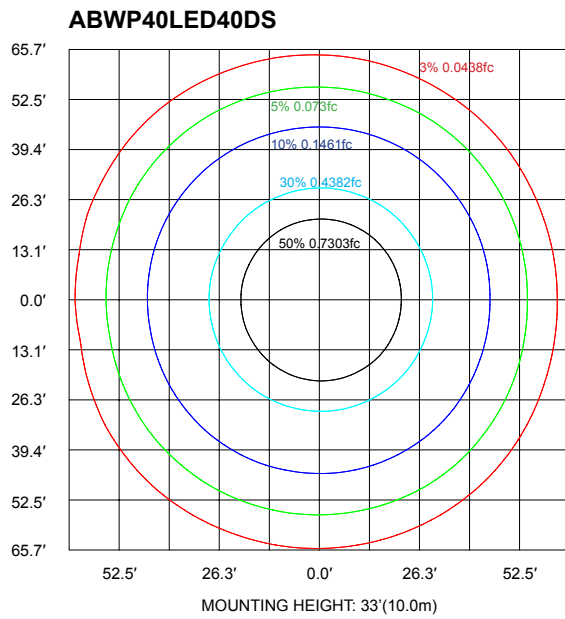
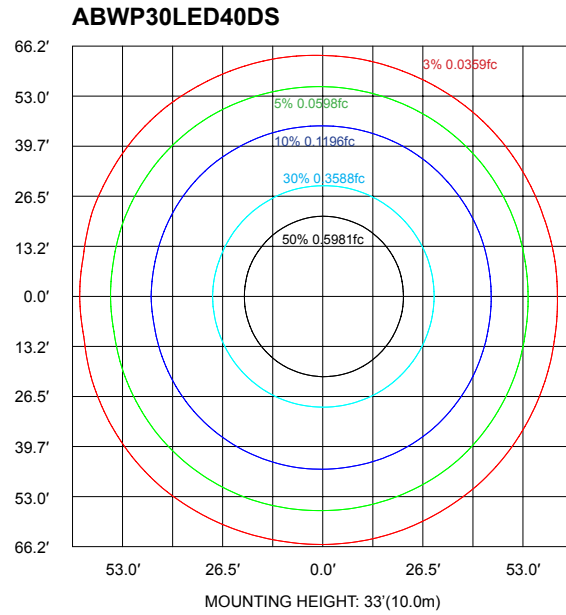
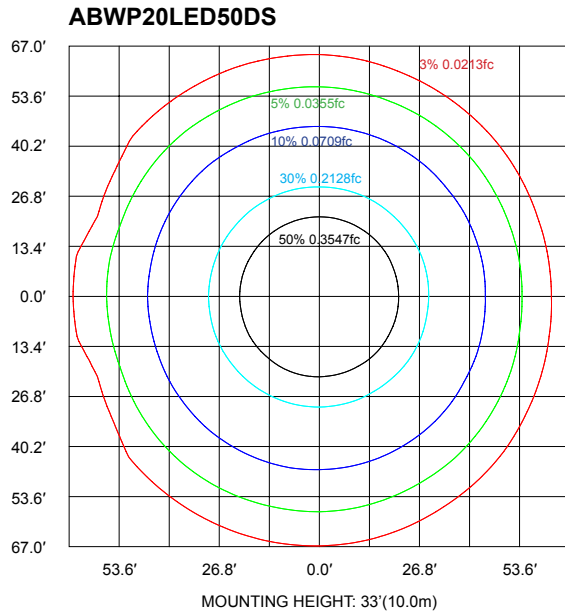

Note: Please visit our website for more details.





TRUCK INSURANCE





■ **FEATURES**

1. Top 5 LED Chip
2. Impact Resistant PC Lens
3. Integrated Photocell For Dusk To Dawn Operation
4. Slim Modern Design

■ **Performance**

Input Watts (LM-79 Reported)	13
Input Voltage	120V
Output Lumens (@5000K)	1667
Replaces (MH)	100W
Lumen Per Watt	135
Color Accuracy (CRI)	>70
Bug Rating	B0-U3-G1
Working Temperature	-40-104°F (-40-40°C)
IP Rating	IP65 rated

■ **Dimensions & Weight**

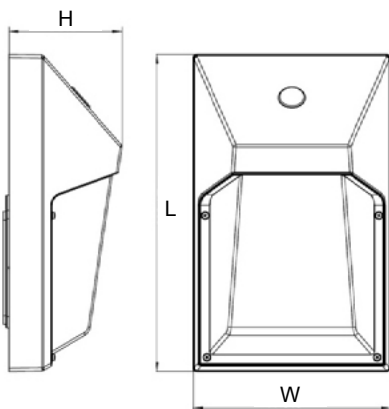

14W

- Length: 10.98"
- Width: 6.84"
- Height: 3.93"
- Max. Weight: 3.39 lbs

■ Ordering Information Example: TRSEC14504

Transformer Series	Security Light	Watts	CCT	Voltage
TR	SEC	14	30 - 3000K 40 - 4000K 50 - 5000K ¹	4 - 120V

Notice:

1. Only 5000K is qualified with DLC Premium.

* Standard Finish as Dark Bronze. Special Order as other finish color - Please Ask Customer Service for Details.

■ Photometry

All published luminaire photometric testing performed to IESNA LM-79-08 standards by a NVLAP certified laboratory.

Mounting Height	10	12	15	18	20	25	33
Multiplier	10.9	7.6	4.9	3.4	2.8	1.8	1

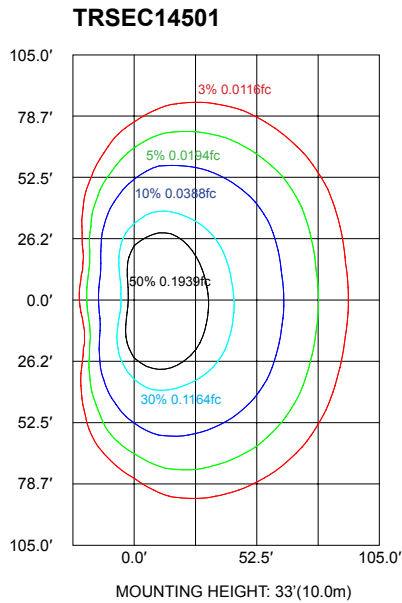

Note: Please visit our website for more details.





■ **FEATURES**

1. High-quality lens
2. Thermally managed construction
3. Heavy duty housing
4. Self-contained driver
5. Uniform color consistency
6. Environmental protection, no heavy metals and harmful gas
7. 120-volt electrical systems, integrated photocell included

■ **Performance**

Input Watts (LM-79 Reported)	11
Input Voltage	120V
Output Lumens (@3000K)	1296
Replaces (MH)	70W
Lumen Per Watt	114
Color Accuracy (CRI)	>70
Bug Rating	B0-U3-G2
Working Temperature	-40-104°F (-40-40°C)
IP Rating	IP65 rated

■ **Dimensions & Weight**

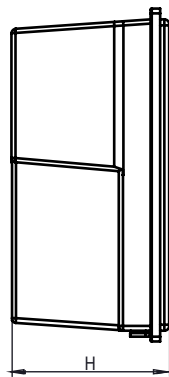
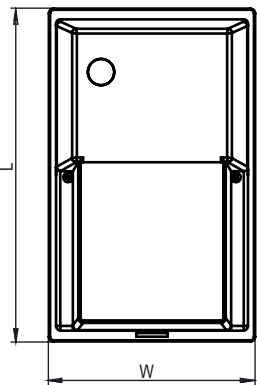

Length: 10.9"
 Width: 6.8"
 Height: 5.2"
 Max. Weight: 3.39 lbs

Traditional Security Light

■ Ordering Information Example: ABBSEC14504

ABOVE ALL	Security Light	Watts	CCT	Voltage
ABB	SEC	14 - 14 Watts	30 - 3000K 40 - 4000K 50 - 5000K	4 - 120V

Notice:

* Standard Finish as Dark Bronze. Special Order as other finish color - Please Ask Customer Service for Details.

■ Photometry

All published luminaire photometric testing performed to IESNA LM-79-08 standards by a NVLAP certified laboratory.

Mounting Height	10	12	15	18	20	25	33
Multiplier	10.9	7.6	4.9	3.4	2.8	1.8	1

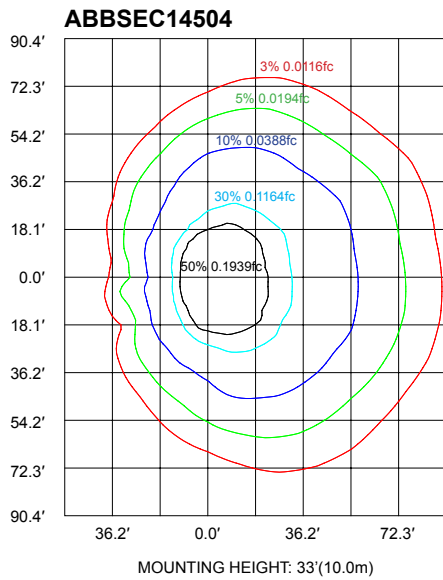

Note: Please visit our website for more details.





AGING / TRANSPORTATION / ATTRACTIONS

A large display board containing numerous small, colorful brochures or flyers, organized in a grid pattern. The brochures feature various images and text, likely related to the categories mentioned in the sign above.

A dark, curved counter or desk with three telephone handsets mounted on it. The counter is positioned in the foreground, angled towards the right.

Restrooms



■ **FEATURES**

1. 3000-14,000 Lumen Package
2. Top 5 LED Chip & LED Driver
3. Knuckle, Trunnion, Slip Fitter Mountings

■ **Performance**

Input Watts (LM-79 Reported)	25	41	52	80	100	120
Input Voltage	120-277	120-277	120-277	120-277	120-277	120-277
Output Lumens (@5000K)	3061	5100	6643	9619	12014	14185
Replaces (MH)	150W	175W	250W	320W	400W	400W
Lumen Per Watt	123	126	128	121	119	117
Color Accuracy (CRI)	>70	>70	>70	>70	>70	>70
Bug Rating	B1-U1-G0	B1-U1-G0	B1-U1-G1	B2-U1-G1	B2-U1-G2	B3-U2-G1
EPA	26W/38W/52W EPA= 0.69 max (depending on mounting type)			80W/100W/120W EPA=0.9 max (depending on mounting type)		
Working Temperature	-40-104°F (-40-40°C)			-40-104°F (-40-40°C)		
IP Rating	IP65 rated			IP65 rated		

■ **Dimensions & Weight**

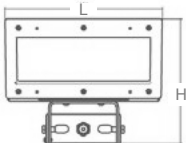
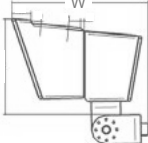
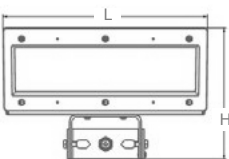
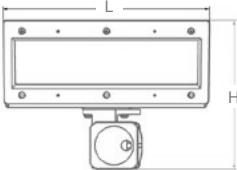
 <p>26W, 38W, 52W Trunnion Length: 10.63"(270mm) Width: 9.17"(233mm) Height: 8.47"(215mm) Max. Weight: 12.5 lbs</p>	 <p>26W, 38W, 52W Knuckle Length: 10.63"(270mm) Width: 8.85"(225mm) Height: 10.35"(263mm) Max. Weight: 14 lbs</p>
 <p>80W, 100W & 120W Trunnion Length: 13.46"(342mm) Width: 9.09"(231mm) Height: 8.47"(215mm) Max. Weight: 16.1 lbs</p>	 <p>80W, 100W & 120W Slip Fitter Length: 13.46"(342mm) Width: 8.39"(210mm) Height: 9.69"(246mm) Max. Weight: 17.3 lbs</p>

■ **Installation**

OPTION 1: TRUNNION



OPTION 2: 1/2" X 14 NPS KNUCKLE MOUNTING

Knuckle only for 26W, 38W, & 52W



OPTION 3: SLIP FITTER

2-3/8" slip fitter is commonly used to 80W, 100W & 120W. Optional for 26W, 38W and 52W.



DLC P Glass V-Line Flood Light

Ordering Information Example: FL26504-PC-TR

Flood Light	Watts	CCT	Voltage	Controls	Installation
FL	26 - 26 Watts	30 - 3000K ¹	1 - 120-277V	PC - Photo Control ³	SF - Slip Fitter ⁴
	38 - 38 Watts	40- 4000K	4 - 120V		TR - Trunnion
	52 - 52 Watts	50 - 5000K	5 - 277V		KN - Knuckle ⁵
	70 - 80 Watts		6 - 347V/ 480V ²		
	100 - 100 Watts				
	120 - 120 Watts				

Notice:

- 3000K DLC Premium only qualified with 26W, 38W and 52W.
 - 347V/480V input is unavailable in 26W and 38W.
 - PC is only for 120V or 277V. Without PC, please choose 120-277V.
 - 2-3/8" slip fitter is commonly used to 80W, 100W and 120W. Optional for 26W, 38W and 52W.
 - 1/2" knuckle is only for 26W, 38W, and 52W.
- * Standard Finish as Dark Bronze. Special Order as other finish color - Please Ask Customer Service for Details.

Accessories Information (Order Separately)



Glare shield-S1 3.5"Height, Suitable for V-line flood light 26W/38W/52W

Glare shield-L1 3.5"Height, Suitable for V-line flood light 80W/100W/120W

Photometry

All published luminaire photometric testing performed to IESNA LM-79-08 standards by a NVLAP certified laboratory.

Mounting Height	10	12	15	18	20	25	33
Multiplier	10.9	7.6	4.9	3.4	2.8	1.8	1

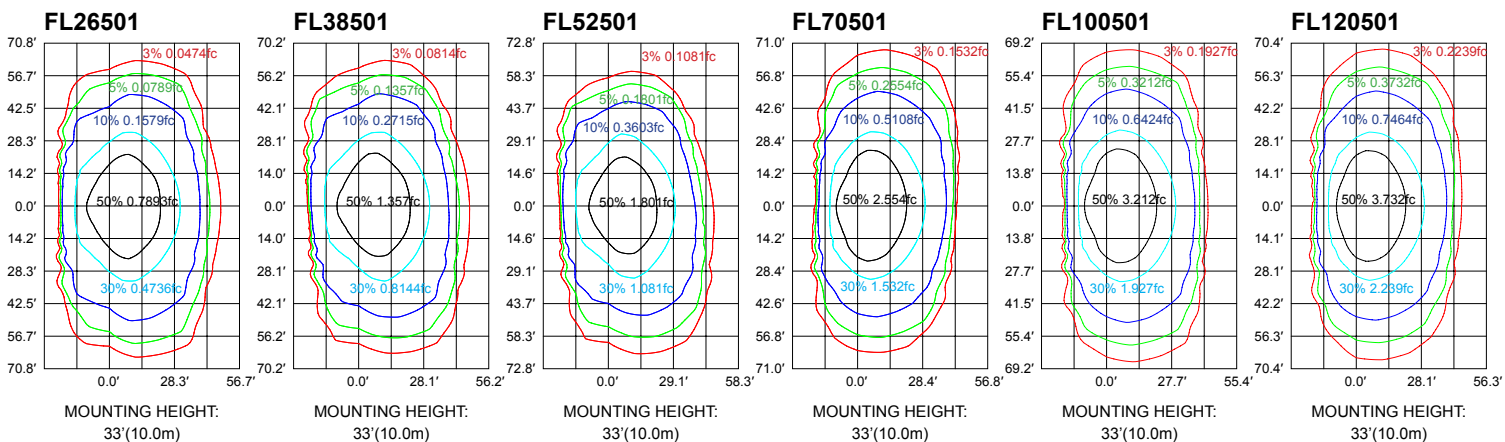

Note: Please visit our website for more details.





■ FEATURES

1. Top 5 LED Chip
2. Modern Yet Classic Design
3. Versatile Design
4. Knuckle, Trunion Mountings

■ Performance

Input Watts (LM-79 Reported)	14	20
Input Voltage	120-277	120-277
Output Lumens (@5000K)	1626	2275
Replaces (MH)	70W	100W
Lumen Per Watt	115	114
Color Accuracy (CRI)	>70	>70
Bug Rating	B1-U1-G0	B1-U1-G0
Working Temperature	-40-104°F (-40-40°C)	-40-104°F (-40-40°C)
IP Rating	IP65 rated	IP65 rated

■ Installation



Flood Light, Knuckle



Flood Light, Trunion

■ Dimensions

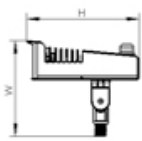

15W&20W Knuckle

Length: 7.2"
Width: 6.2"
Height: 2.44"

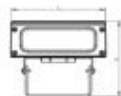
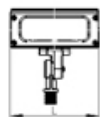

15W&20W Trunion

Length: 7.2"
Width: 5.2"
Height: 2.44"

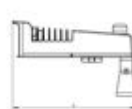

DLC P Architecture Leopard Series Mini Flood Light

■ Ordering Information

Example: MFW15504-PC-KN

Mini Flood and Wall Light	Watts	CCT	Voltage	Controls	Installation
MFW	15 - 15 Watts	30 - 3000K	1 - 120-277V	PC - Photo Control ² (only 120V or 277V)	KN - Knuckle
	20 - 20 Watts	40 - 4000K	4 - 120V		TR - Trunnion
		50 - 5000K ¹	5 - 277V		

Notice:

1. Only 5000K is qualified with DLC Premium.

2. PC is only for 120V or 277V. Without PC, please choose 120-277V.

* Standard Finish as Dark Bronze. Special Order as other finish color - Please Ask Customer Service for Details.

■ Photometry

All published luminaire photometric testing performed to IESNA LM-79-08 standards by a NVLAP certified laboratory.

Mounting Height	10	12	15	18	20	25	33
Multiplier	10.9	7.6	4.9	3.4	2.8	1.8	1

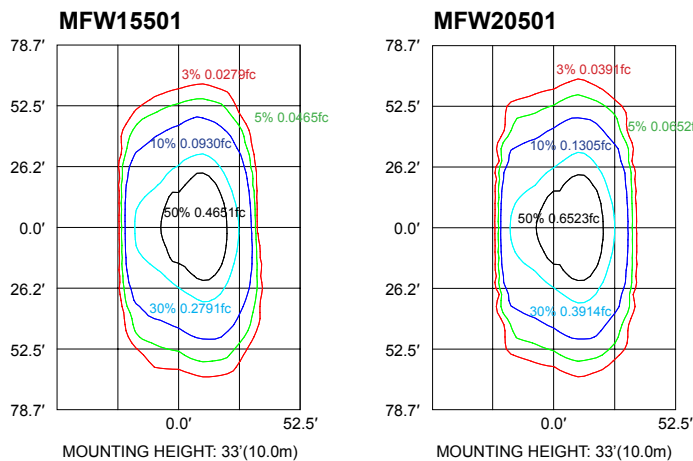

Note: Please visit our website for more details.





■ **FEATURES**

1. Top 5 LED Chip
2. Reflector design with tempered glass lens doesn't fade and discolor
3. Durable die-cast aluminum housing with high thermal transfer rate
4. Optional motion sensor for maximum energy savings.
5. DLC listed.

■ **Performance**

Input Watts (LM-79 Reported)	14	24	43
Input Voltage	120-277	120-277	120-277
Output Lumens (@5000K)	1400	2400	4300
Replaces (MH)	70W	100W	175W
Lumen Per Watt	100	100	100
Color Accuracy (CRI)	>70	>70	>70
Working Temperature	-40-104°F (-40-40°C)	-40-104°F (-40-40°C)	-40-104°F (-40-40°C)
IP Rating	IP65 rated	IP65 rated	IP65 rated

■ **Dimensions & Weight**

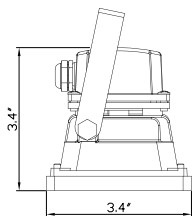
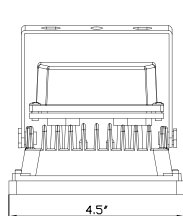

ABBFL15LED50

Depth: 3.4"
Width: 4.5"
Length: 3.4"
Max. Weight: 2.5 lbs

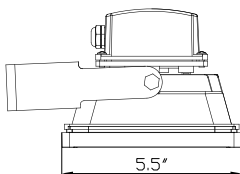
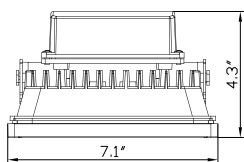

ABBFL25LED50

Depth: 4.3 "
Width: 7.1"
Length: 5.5"
Max. Weight: 4 lbs

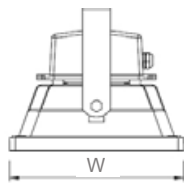
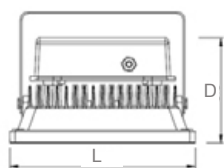

ABBFL45LED50

Depth: 5"
Width: 7.5"
Length: 9"
Max. Weight: 6.5 lbs

Glass Lens Mini Flood Light With 110° Beam Angle

Ordering Information Example: ABBFL45LED50

ABOVE ALL	Flood Light	Watts	Source type	CCT
ABB	FL	15 - 14 Watts	LED	30 - 3000K
		25 - 24 Watts		40 - 4000K
		45 - 42 Watts		50 - 5000K ¹

Notice:

1. DLC listed only with 5000K at present.

* Standard Finish as Dark Bronze. Special Order as other finish color - Please Ask Customer Service for Details.

Photometry

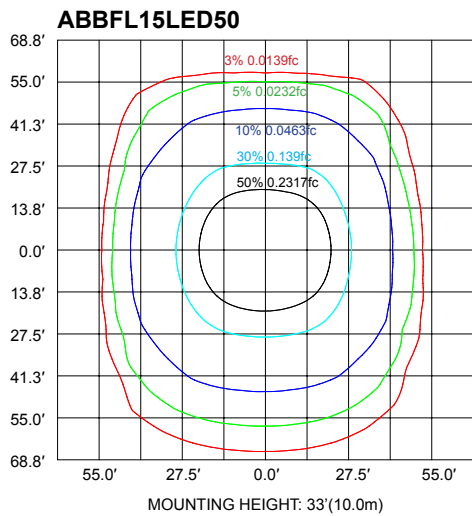

All published luminaire photometric testing performed to IESNA LM-79-08 standards by a NVLAP certified laboratory.

Mounting Height	10	12	15	18	20	25	33
Multiplier	10.9	7.6	4.9	3.4	2.8	1.8	1

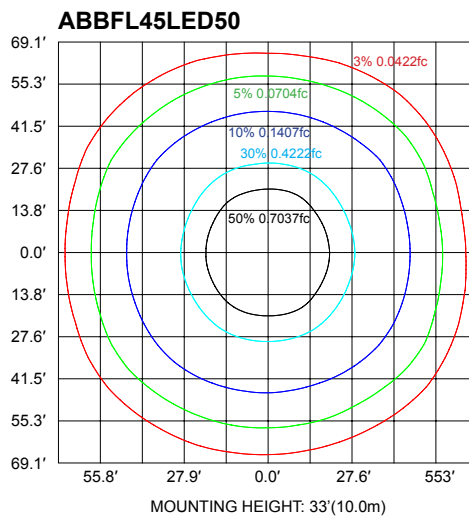
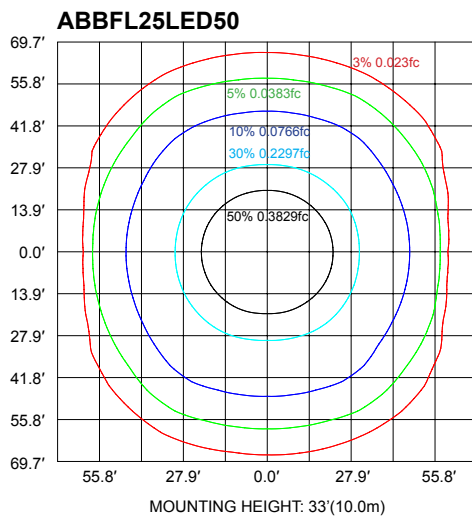

Note: Please visit our website for more details.









■ **FEATURES**

1. Tempered Glass Lens
2. Up to 29,000 lm
3. Full Lighting Distributions
4. Special Reflector Design

■ **Performance**

Input Watts (LM-79 Reported)	104	160	197
Input Voltage	120-277	120-277	120-277
Output Lumens (@5000K)	12480	18868	21046
Replaces (MH)	400W	600W	800W
Lumen Per Watt	120	118	107
Color Accuracy (CRI)	>70	>70	>70
Bug Rating	MT100501-III B3-U0-G2 MT100501-VW B3-U0-G2	MT150501-III B3-U0-G2 MT150501-VW B4-U0-G2	MT200501-III B3-U0-G2 MT200501-VW B4-U0-G2
EPA	100W/150W/200W EPA=1.46 max (depending on mounting type)		
Working Temperature	-40-104°F (-40-40°C)	-40-104°F (-40-40°C)	-40-104°F (-40-40°C)
IP Rating	IP66 rated	IP66 rated	IP66 rated

■ **Installation**

OPTION 1: POLE INSTALLATION



Round pole



Square pole

OPTION 2: UNIVERSAL SLIP FITTER INSTALLATION

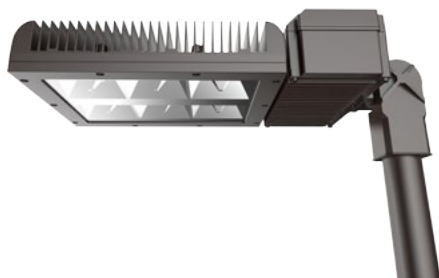

OPTION 3: FLOOD LIGHT TRUNNION / YOKE INSTALLATION



■ Dimensions & Weight

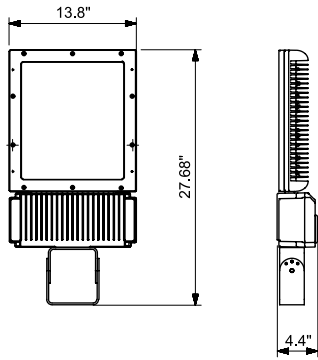

100W, 150W, 200W
Trunnion
 Length: 27.68"
 Width: 13.8"
 Height: 4.4"
 Max Weight: 11.6kg/25.6lbs

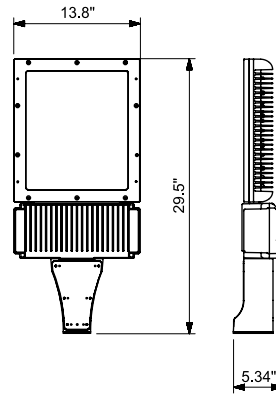

100W, 150W, 200W
Square Arm
 Length: 29.5"
 Width: 13.8"
 Height: 5.34"
 Max Weight: 11.6kg/25.6lbs

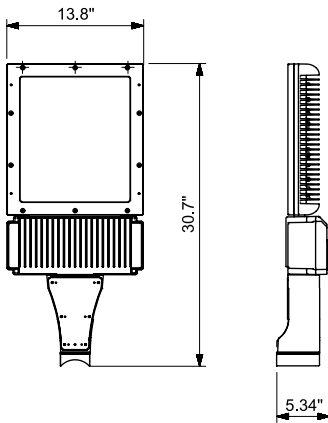

100W, 150W, 200W
Round Extended Arm
 Length: 30.7"
 Width: 13.8"
 Height: 5.34"
 Max Weight: 11.6kg/25.6lbs

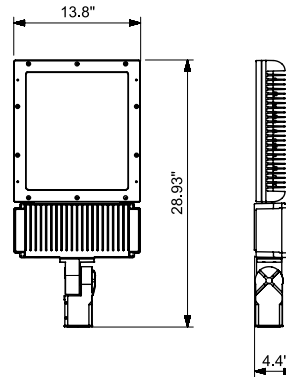

100W, 150W, 200W
Slip Fitter
 Length: 28.93 "
 Width: 13.8 "
 Height: 4.4"
 Max Weight: 11.6kg/25.6lbs

■ Ordering Information

Example: MT150501-PC-TR-VW

MT	Watts	CCT	Voltage	Controls	Installation	Distribution	Finish
MT	100 - 100 Watts	30 - 3000K	1 - 120-277V	Blank - None	SF - Slip Fitter	III - Type III	Blank - Dark
	150 - 150 Watts	40 - 4000K	2 - 347V ¹	MS-L7B - Motion Sensor with Black L7 Lens ⁴	TR - Trunnion	VW - Type V Wide	Bronze
	200 - 200 Watts	50 - 5000K	3 - 480V ²	MS-L7W - Motion Sensor with White L7 Lens ⁴	AR - Square Arm ⁶	VN - Type V Narrow	AL - Aluminum Silver
			6 - 347V/480V ³	PC - Photoelectric Control		VM - Type V Middle	
				7P - 7 Pin PE Receptacle ⁵		IV - Type IV	

Note:

- 347V is only used with photoelectric control .
- 480V is only used with photoelectric control.
- If choose 347/480V, please do not choose photoelectric control.
- The standard MS L7 lens is suitable for the mounting height of 6m (20ft) and higher.
- Shorting cap included.
- Round pole adapter need to be bought separately for a round pole.

*Please Ask Customer Service for any special requests.

■ Accessories Information (Order Separately)



MT-Round Pole Adapter
1.22" arm mount adapter for round pole,
suitable for MT line 100W, 150W and 200W



MT-HSS
House-side shield for 100W, 150W, 200W MT



MT-HRS
House-rear shield for 100W, 150W, 200W MT

■ Photometry

All published luminaire photometric testing performed to IESNA LM-79-08 standards by a NVLAP certified laboratory.

Mounting Height	10	12	15	18	20	25	33
Multiplier	10.9	7.6	4.9	3.4	2.8	1.8	1

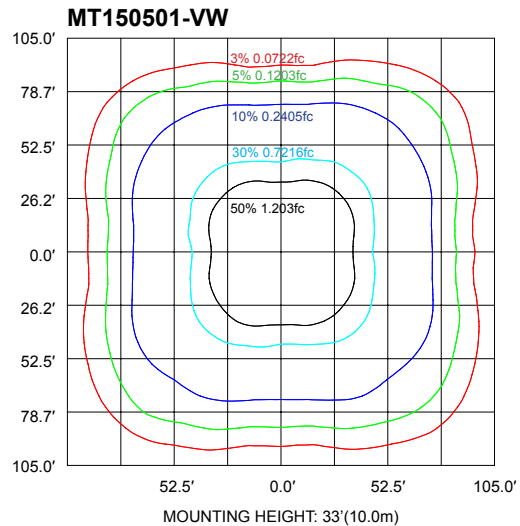
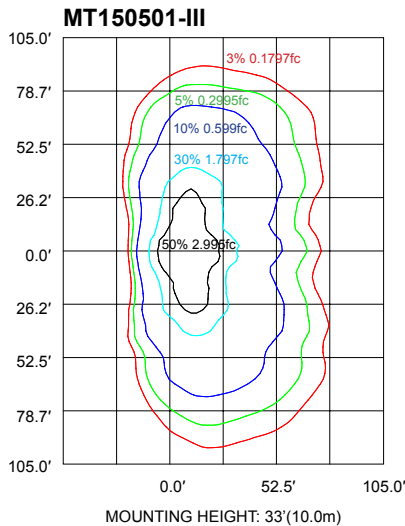
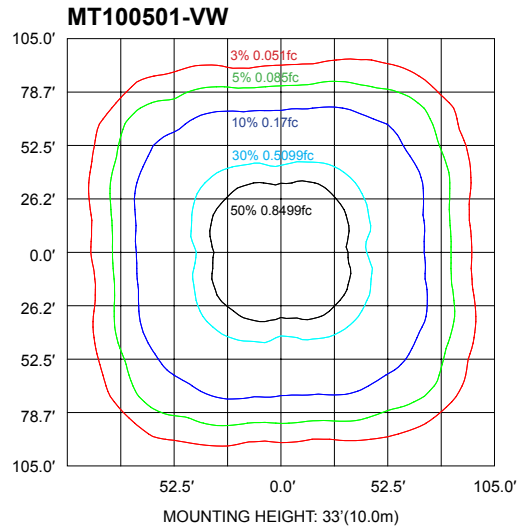
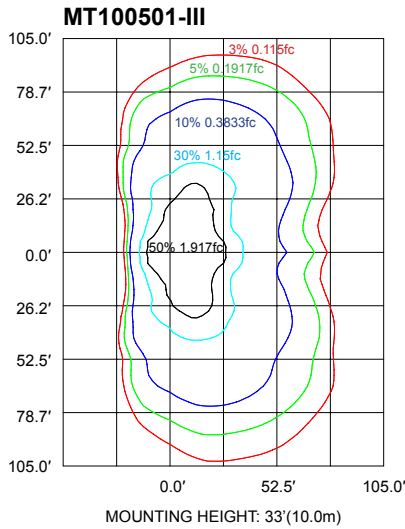

DLC P Glass Lens MT Universal Light

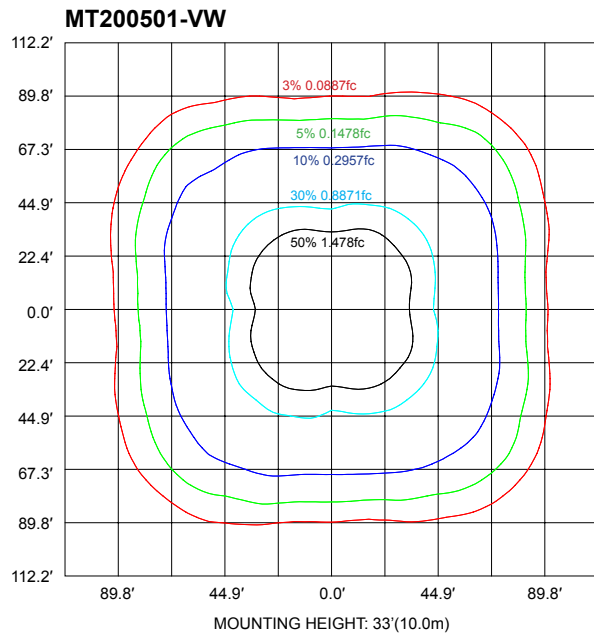
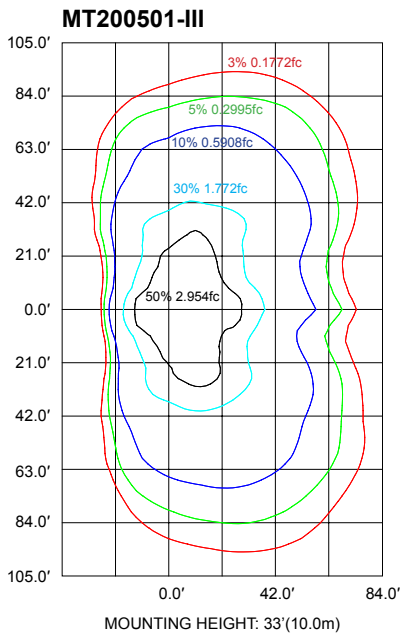

DLC Premium is only for 100W 5000K in all distributions and 150W 5000K in type V. The others are DLC standard.

Note: Please visit our website for more details.





■ **FEATURES**

1. 40W to 80W
2. Low EPA 0.53 Sq.Ft.
3. Tempered Glass Lens
4. Full Lighting Distributions

■ **Performance**

Input Watts (LM-79 Reported)	44.5	63.7	77.9
Input Voltage	120-277	120-277	120-277
Output Lumens (@5000K)	5150	7644	9146
Replaces (HPS)	70W	100W	150W
Lumen Per Watt	116	120	117
Color Accuracy (CRI)	>70	>70	>70
Dist. Type	TypeV	TypeV	TypeV
EPA	with Arm, EPA = 0.53 ft ²	with Slipfitter, EPA = 0.55 ft ²	with Trunnion, EPA = 0.47 ft ²
Working Temperature	-40-122°F (-40-50°C)	-40-122°F (-40-50°C)	-40-122°F (-40-50°C)
IP Rating	IP66 rated	IP66 rated	IP66 rated

■ **Installation**



Arm Mount



Trunnion Mount



Slipfitter Mount

■ Dimensions & Weight

Arm Mount

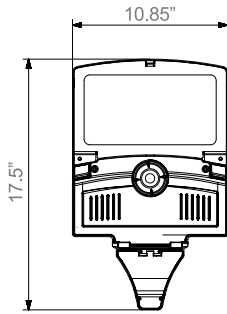

FACE VIEW

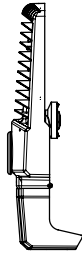

SIDE VIEW

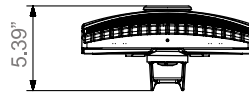

FRONT VIEW

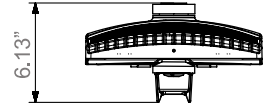

FRONT VIEW
WITH RECEPTACLE

Slipfitter Mount

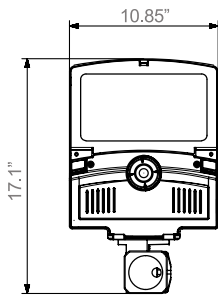

FACE VIEW

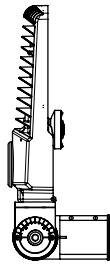

SIDE VIEW

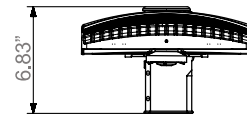

FRONT VIEW

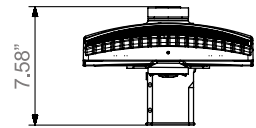

FRONT VIEW
WITH RECEPTACLE

Trunnion Mount

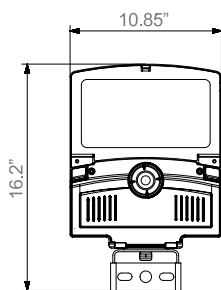

FACE VIEW

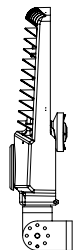

SIDE VIEW

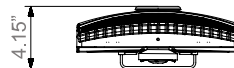

FRONT VIEW

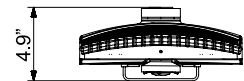

FRONT VIEW
WITH RECEPTACLE

■ Ordering Information

Example: SMT40401-7P-SAR-T2

SMT	Watts	CCT	Voltage	Control	Installation	Distribution	Finish
SMT	40 - 40W	30 - 3000K	1 - 120-277V	Blank - None	SAR - Square	T2 -Type II	Blank - Dark
	60 - 60W	40 - 4000K	2 - 347V¹	MS-L3B - Motion	Pole Arm	T3 - Type III	Bronze
	80 - 80W	50 - 5000K	3 - 480V²	Sensor with Black	RAR - Round	T4 - Type IV	AL -
			6 - 347/480³	L3 Lens ⁴	Pole Arm ⁶	T5 - Type V	Aluminum
				MS-L3W - Motion	TR - Trunnion		Silver
				Sensor with White	SF - Slip Fitter⁷		
				L3 Lens ⁴			
				PC - Photoelectric			
				Control			
				7P - 7 Pin PE			
				Receptacle ⁵			

Notes:

- 347V is only used with photoelectric control .
- 480V is only used with photoelectric control.
- If choose 347/480V, please do not choose photoelectric control.
- The standard MS L3 lens is suitable for the mounting height of 20ft (6m) Max. If higher than 20ft (6m), please contact Customer Service to choose L7 lens.
- Shorting cap included.
- Round Pole Adapter need to be bought separately for round pole arm mounting. Please check following accessory table for details.
- The slip fitter fits a 2 3/8" O.D. tenon or pole.

Please check following accessory table for details.

■ Accessories Information (Order Separately)



SMT-RPA

Arm mount adapter for round pole, suitable
for SMT series 40W, 60W and 80W

■ Photometry

All published luminaire photometric testing performed to IESNA LM-79-08 standards by a NVLAP certified laboratory.

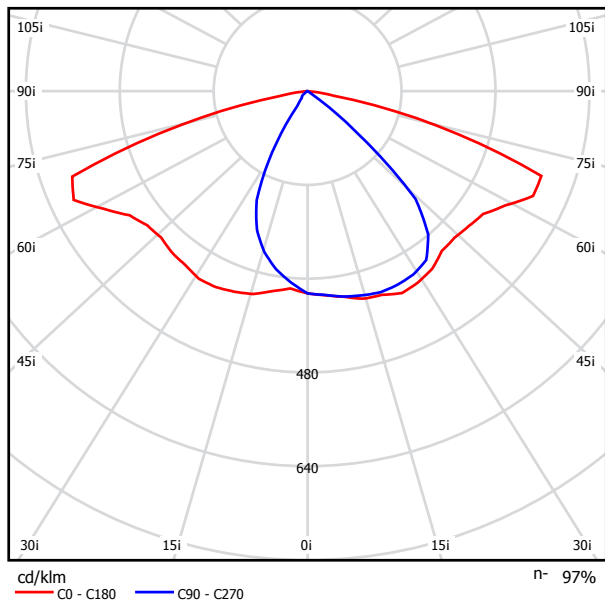

Type II

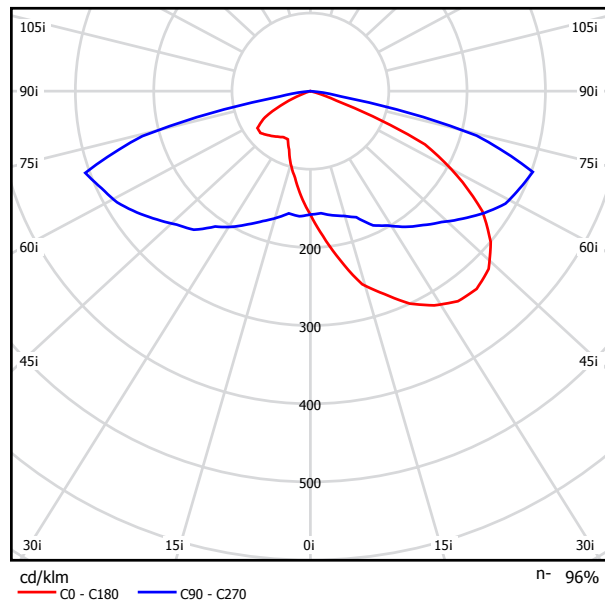

Type III

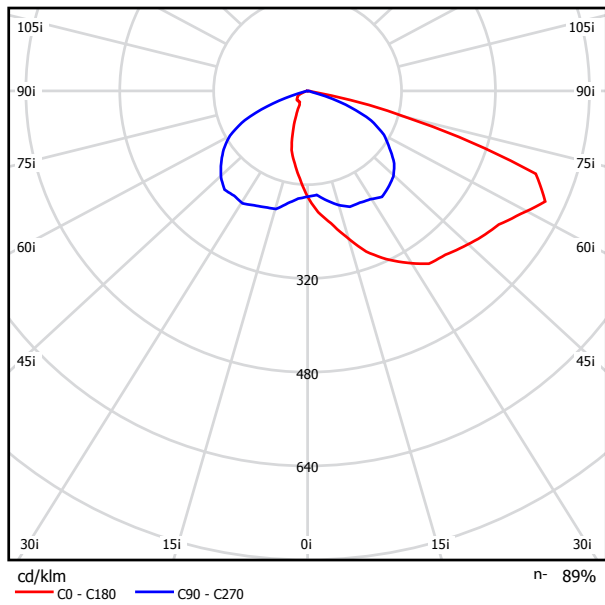

Type IV

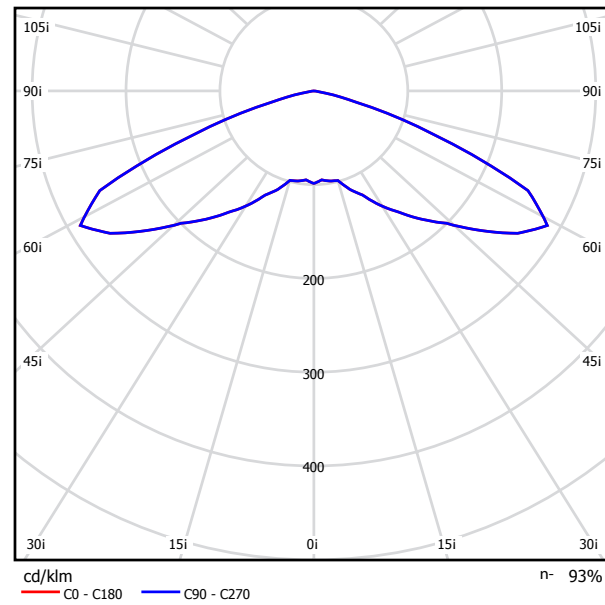

Type V

Note: Please visit our website for more details.







200-40 Building
This building is for
the use of the
community.
Please do not
use this building
for any other
purpose.
Thank you for
your cooperation.



■ **FEATURES**

1. Tempered Glass Lens
2. Slim Low Profile Design
3. Top 5 LED Chip & LED Driver
4. Patented Air Cooling Design Weep Holes
5. Surface Or Pendant Mountings Optional



Slim design less than 2"

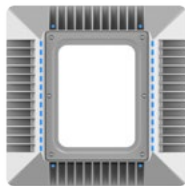

Patented air cooling design weep holes: solving the problems of water on the back of the fixture and better heat dissipation



Surface/ pendant mount



Separated driver box :
A better thermal design

■ **Performance**

Input Watts (LM-79 Reported)	64	95	120
Input Voltage	120-277	120-277	120-277
Output Lumens (@5000K)	9403	13677	17780
Replaces (MH)	250W	400W	400-600W
Lumen Per Watt	147	143	148
Color Accuracy (CRI)	>80	>80	>80
Working Temperature	-40-104°F (-40-40°C)	-40-104°F (-40-40°C)	-40-104°F (-40-40°C)
IP Rating	IP65 rated	IP65 rated	IP65 rated

■ **Dimensions & Weight**

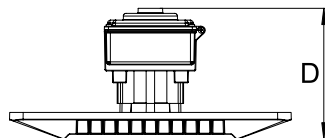
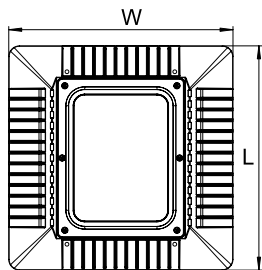

Including Driver

Depth: 7.68"
Width: 16.38"
Length: 18.98"

Excluding driver

Depth: 1.58"
Width: 16.38"
Length: 18.98"

Max. Weight: 13.5lbs

Ordering Information Example: PDG120501

PAD Design	Watts	CCT	Voltage
PDG	65 - 65 Watts	30 - 3000K ¹	1 - 120-277 V
	100 - 100 Watts	40 - 4000K	6 - 347/480V
	120 - 120 Watts	45 - 4500K	
		50 - 5000K	

Notice:

1. 3000K DLC Premium is unavailable

* Standard Finish as White. Special Order as other finish color - Please Ask Customer Service for Details.

Photometry

All published luminaire photometric testing performed to IESNA LM-79-08 standards by a NVLAP certified laboratory.

Mounting Height	10	12	15	18	20	25	33
Multiplier	10.9	7.6	4.9	3.4	2.8	1.8	1

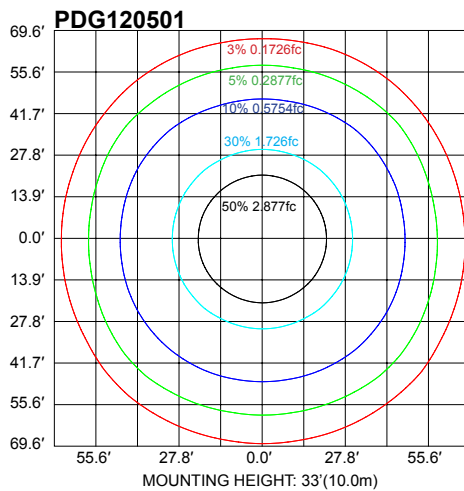
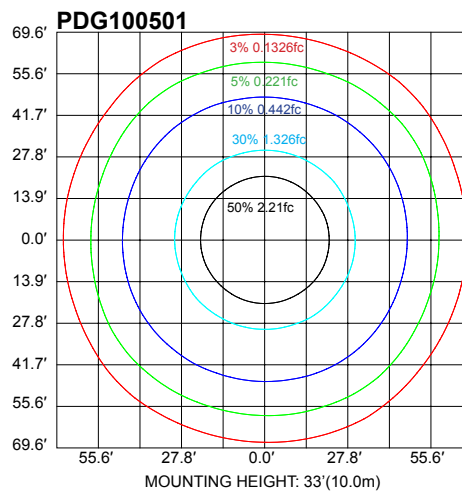
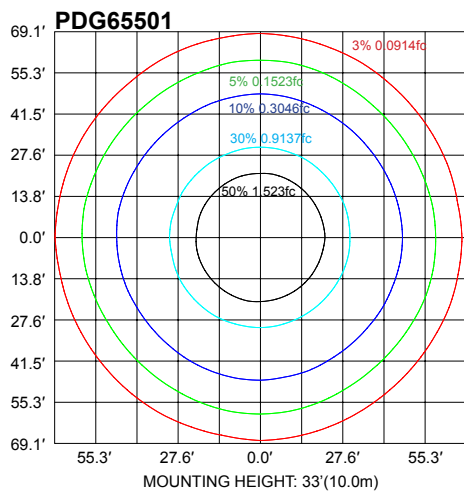

Note: Please visit our website for more details.





■ **FEATURES**

1. Impact Resistant Prismatic Lens
2. Superior Low-glare Illumination
3. Top 5 LED Chip & LED Driver
4. Patented Air Cooling Design
5. Surface Or Pendant Mountings
6. EBU Backup Available

■ **Performance**

Input Watts (LM-79 Reported)	34	68
Input Voltage	120-277	120-277
Output Lumens (@5000K)	4533	9214
Replaces (MH)	175W	320W
Lumen Per Watt	133	136
Color Accuracy (CRI)	>80	>80
Working Temperature	-40-104°F (-40-40°C)	-40-104°F (-40-40°C)
IP Rating	IP65 rated	IP65 rated

■ **Dimensions & Weight**

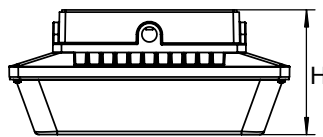
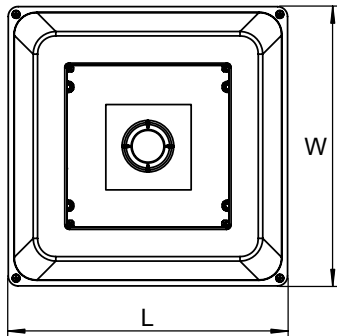

Length: 12"
Width: 12"
Height: 3.7"
Max. Weight: 10.12 lbs

■ **Ordering Information**

Example: LSPKG35501P-MS-L2B

LS Parking Garage Series	Watts	CCT	Voltage	Series	Controls	MS LENS
LSPKG	35 - 35 Watts	30 - 3000K	1 - 120-277V	P - DLC	MS - Multi-level Motion Sensor ²	L2B - L2 Lens Black ⁴
	65 - 65 Watts	40 - 4000K	6 - 347/480V ¹	Premium	EBU - Emergency Battery Backup ³	L7B - L7 Lens Black ⁵
		50 - 5000K				

Notice:

1. DLC Premium is unavailable in high voltage version. And, no high voltage solution for 35W.
2. No motion sensor option for 347/480V input fixture
3. In the event of a power failure, the battery backup units switch to emergency mode (950 lumen output) and operates the fixture for a minimum of 90 minutes. And, the working temperature is 32-104°F
4. Default setting for 35W. Please contact customer service for more options
5. Default setting for 65W. Please contact customer service for more options.

* Standard Finish as White and Dark Bronze. Special Order as other finish color - Please Ask Customer Service for Details.

■ Photometry

All published luminaire photometric testing performed to IESNA LM-79-08 standards by a NVLAP certified laboratory.

Mounting Height	10	12	15	18	20	25	33
Multiplier	10.9	7.6	4.9	3.4	2.8	1.8	1

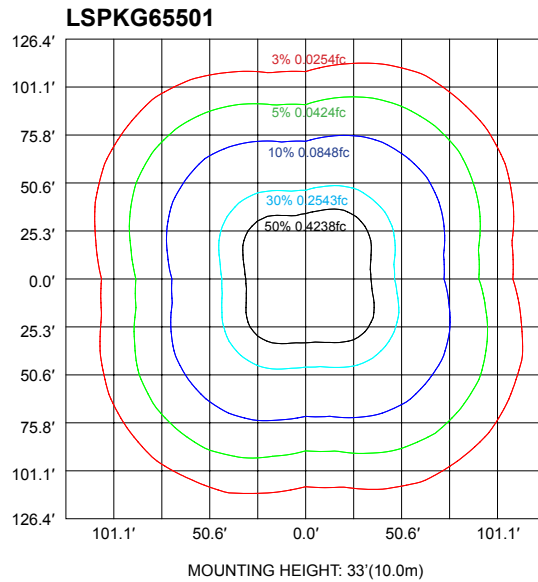
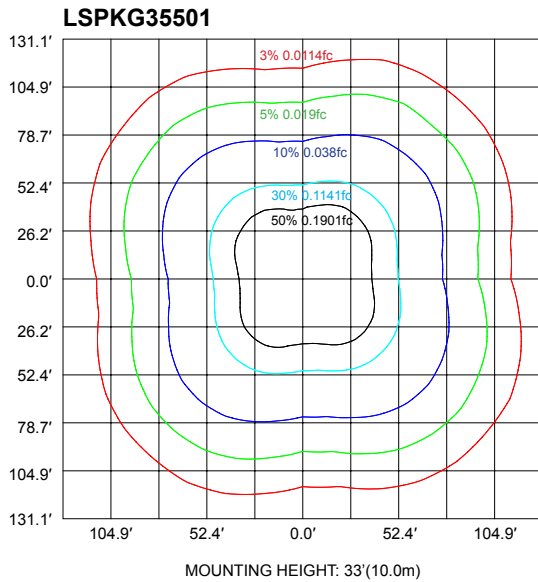

Note: Please visit our website for more details.





■ **FEATURES**

1. Top 5 LED Chip & LED Driver
2. PC Lens Provides An Even Light Distribution

■ **Performance**

Input Watts (LM-79 Reported)	37	49	65
Input Voltage	120-277	120-277	120-277
Output Lumens (@5000K)	3590	4732	6160
Replaces (MH)	150W	250W	350W
Lumen Per Watt	98	97	95
Color Accuracy (CRI)	>70	>70	>70
Working Temperature	-40-104°F (-40-40°C)	-40-104°F (-40-40°C)	-40-104°F (-40-40°C)
IP Rating	IP65 rated	IP65 rated	IP65 rated

■ **Dimensions & Weight**

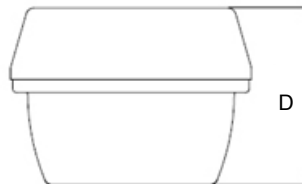
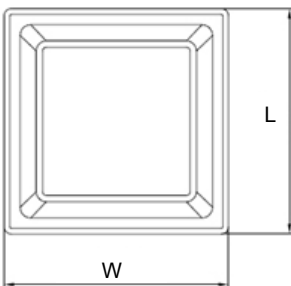

Depth: 9.06"
Width: 12.4"
Length: 12.4"
Max. Weight: 7.7 lbs

■ **Ordering Information**

Example: ABPKG40LED50-PC12/ ABBPKG70501-PC12

ABOVE ALL	Parking Garage	Watts	Source Type	CCT	Controls
AB	PKG	40 - 38 Watts	LED	30 - 3000K	PC12 - Photo control 120V
				40 - 4000K	PC27 - Photo control 277V
				50 - 5000K ¹	Leave blank for no controls

ABOVE ALL	Parking Garage	Watts	CCT	Voltage	Controls
ABB	PKG	55 - 52 Watts	30 - 3000K	1 - 120-277 V	PC12 - Photo control 120V
		70 - 70 Watts	40 - 4000K		PC27 - Photo control 277V
			50 - 5000K ¹		Leave blank for no controls

Notice:

1. Only 5000K is qualified with DLC.

* Standard Finish as Dark Bronze. Special Order as other finish color - Please Ask Customer Service for Details.

■ Photometry

All published luminaire photometric testing performed to IESNA LM-79-08 standards by a NVLAP certified laboratory.

Mounting Height	10	12	15	18	20	25	33
Multiplier	10.9	7.6	4.9	3.4	2.8	1.8	1

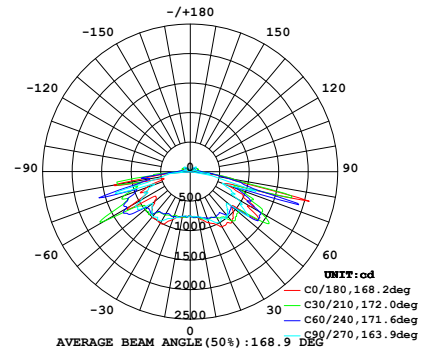
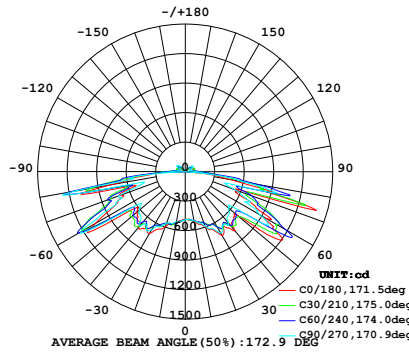
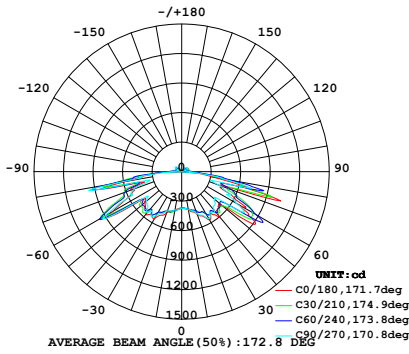
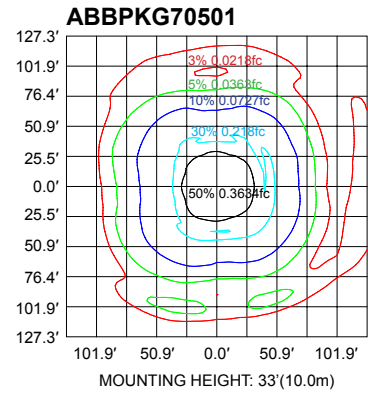
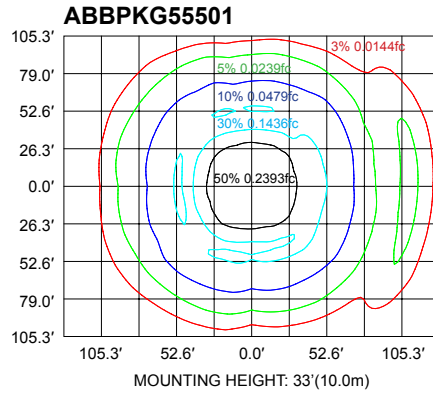
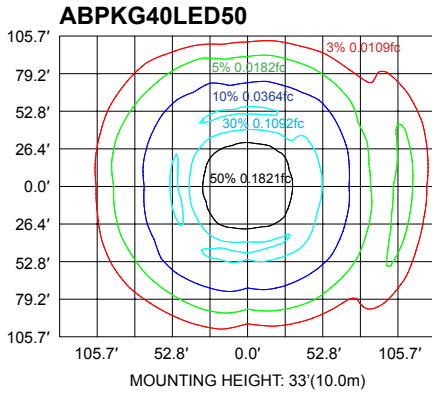

Note: Please visit our website for more details.





■ **FEATURES**

1. High-quality lens
2. Energy savings
3. Indoor or outdoor use
4. Uniform color consistency
5. Self-contained LED driver

■ **Performance**

Input Watts (LM-79 Reported)	21	35	49	66
Input Voltage	120-277	120-277	120-277	120-277
Output Lumens (@5000K)	2732	4092	4849	6302
Replaces (MH)	100W	150W	175W	250W
Lumen Per Watt	129	118	99	96
Color Accuracy (CRI)	>70	>70	>70	>70
Working Temperature	-40-104°F (-40-40°C)	-40-104°F (-40-40°C)	-40-104°F (-40-40°C)	-40-104°F (-40-40°C)
IP Rating	IP65 rated	IP65 rated	IP65 rated	IP65 rated

■ **Dimensions & Weight**

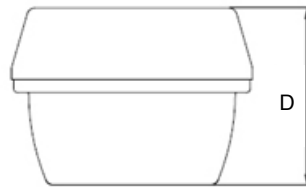
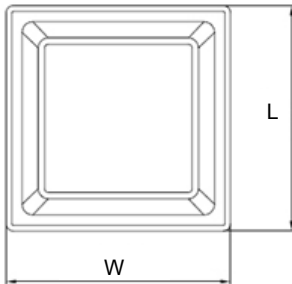

20W

Depth: 8.85"
Width: 8.85"
Length: 7.28"
Max. Weight: 3.8 lbs

38W, 52W, 70W

Depth: 9.06"
Width: 12.4"
Length: 12.4"
Max. Weight: 8.6 lbs

■ **Ordering Information**

Example: ABBCAN40501

ABOVE ALL	CANOPY	Watts	CCT	Voltage
ABB	CAN	20 - 20 Watts ¹	30 - 3000K ²	1 - 120-277 V
		40 - 38 Watts	40 - 4000K ³	
		55 - 52 Watts	50 - 5000K ⁴	
		70 - 70 Watts		

Notice:

1. 20 watts version is non-dimmable.
2. Only 20W 3000K qualified with DLC Premium.
3. Only 20W and 38W 4000K is qualified with DLC Premium.
4. 20W 5000K is DLC Premium listed. 38W, 52W and 70W are DLC standard listed.

* Standard Finish as Dark Bronze. Special Order as other finish color - Please Ask Customer Service for Details.

■ Photometry

All published luminaire photometric testing performed to IESNA LM-79-08 standards by a NVLAP certified laboratory.

Mounting Height	10	12	15	18	20	25	33
Multiplier	10.9	7.6	4.9	3.4	2.8	1.8	1

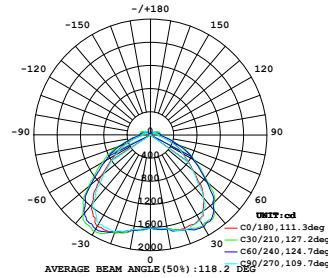
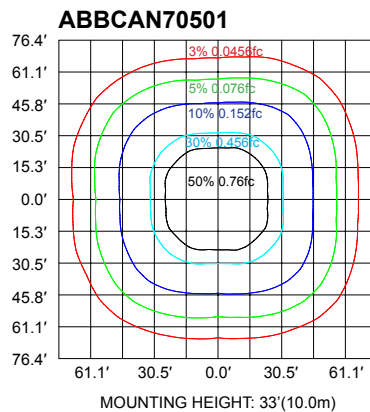
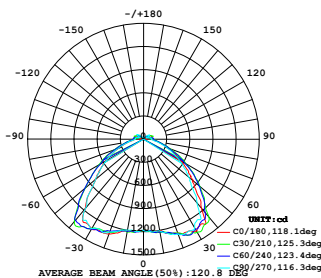
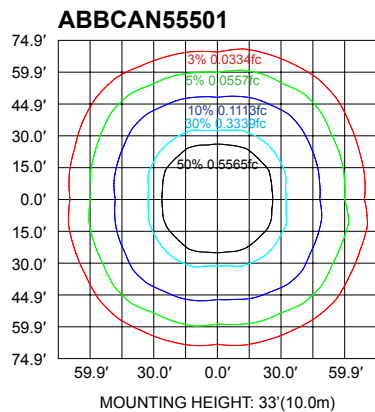
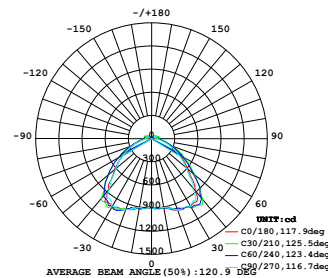
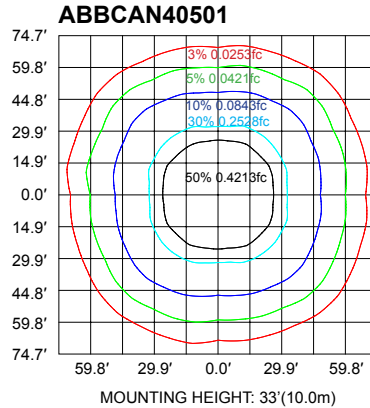
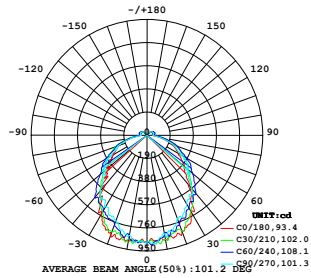
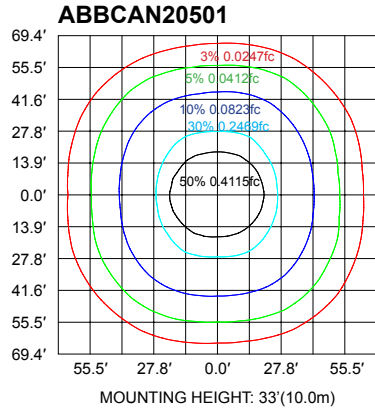

Note: Please visit our website for more details.









■ **FEATURES**

1. Tempered Glass Lens
2. 347/480V available
3. Replaces up to 750W HID
4. In Beaming Angle of 60°/90°/120°

■ **Performance**

Input Watts	100	150	200	240
Input Voltage	120-277	120-277	120-277	120-277
Output Lumens (@5000K)	12500	18750	25000	30000
Replaces (MH)	400W	600W	800W	1000W
Lumen Per Watt	125	125	125	125
Color Accuracy (CRI)	>80	>80	>80	>80
Working Temperature	-4-104°F (-20-40°C)	-4-104°F (-20-40°C)	-4-104°F (-20-40°C)	-4-104°F (-20-40°C)
IP Rating	IP65 rated	IP65 rated	IP65 rated	IP65 rated

■ **Dimensions & Weight**

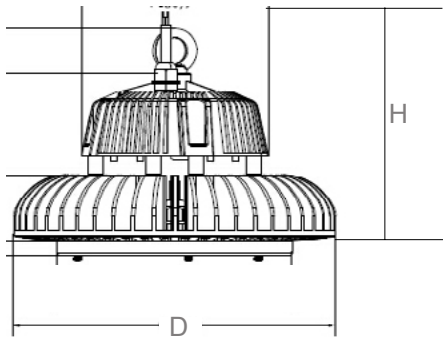

100W & 150W

Φ10.23"X7.08"

(Φ260*183mm)

Max. Weight: 11.24 lbs

200W

Φ11.48"X8.19"

(Φ290*208mm)

Max. Weight: 12.79 lbs

240W

Φ11.48"X8.58"

(Φ290*218mm)

Max. Weight: 14.11 lbs

■ **Installation**

1. CEILING WITH HOOK

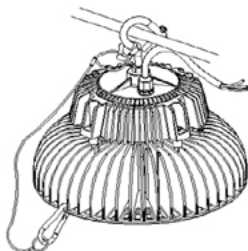

2. WALL MOUNTING

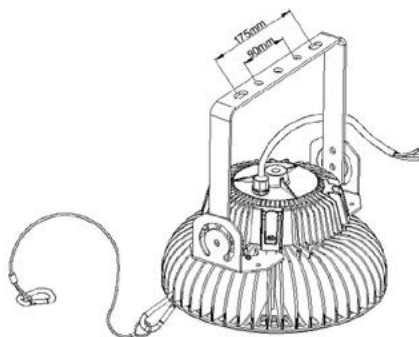

3. PENDANT MOUNTING

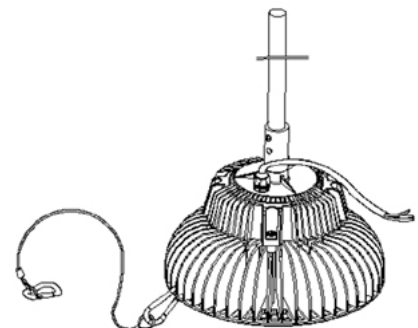

■ Accessories Information (Order Separately)



AB-AL-60D

60 degree aluminium reflector



AB-PC-70D

70 degree PC reflector



AB-AL-90D

90 degree aluminium reflector



AB-PC-DGS

PC Drop glare shield



AB-PC-CGS

PC Clear conical glare shield



AB-AL-GS

Glare shield

■ Ordering Information

Example: URHB100LED501

UFO Round High Bay	Watts	Source type	CCT	Voltage	Controls	Installation	Distribution	Options
URHB	100 - 100	LED	30 - 3000K	1 - 120-277VAC	Blank - No	Blank-Hook	Blank-120° ³	Blank - None
	Watts		40 - 4000K	6 - 347/480V	Controls	with Safety	Shipped	PCL-Polycarbonate Clear Lens
	150 - 150		50 - 5000K		MSW -	Chain	Separately ⁴	PFL-Polycarbonate Frosted lens
	Watts				Microwave Motion	TR - Trunnion	60 - 60°	Shipped Separately ⁴
	200 - 200				Sensor ²	P - Pendent ⁵	70 - 70°	GS - Glare Shield
	Watts						90 - 90°	CGS - Clear Conical Glare Shield
	240 - 240							DGS - Drop Glare Shield
	Watts							WGAL-Wire Guard ⁶

Notice:

1. DLC Listed only with 4000K and 5000K at present.
2. The motion sensor solution is only for 120-277V.
3. Standard distribution is 120° without any reflector. If for 60°/70°/90° need to match with different reflectors. For details please kindly check the accessories table.
4. Also available as accessories. For details please kindly check the accessories table.
5. 3/4" pendent mount adaptor.
6. It is suitable for 60 degree and 90 degree aluminum reflectors.

■ Photometry

All published luminaire photometric testing performed to IESNA LM-79-08 standards by a NVLAP certified laboratory.

Mounting Height	10	12	15	18	20	25	33
Multiplier	10.9	7.6	4.9	3.4	2.8	1.8	1

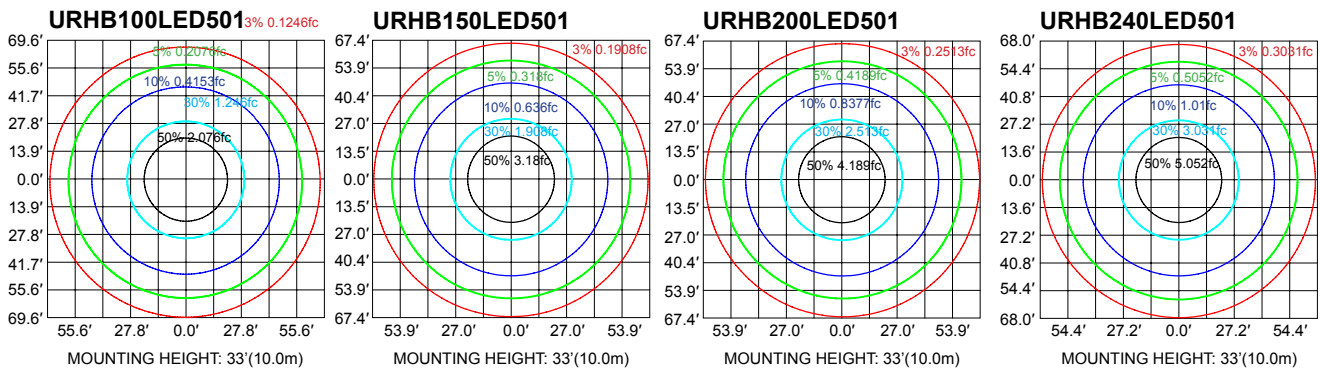

Note: Please visit our website for more details.





■ **FEATURES**

1. Top 5 LED Chip & LED Driver
2. EBU Backup Available
3. Reflector Providing 82 Degree Beam Angle

■ **Performance**

Input Watts (LM-79 Reported)	119	151	182
Input Voltage	120-277	120-277	120-277
Output Lumens (@5000K)	16489	20607	25290
Replaces (FL)	6 Lamp - 32W T8	4 Lamp - 54W T5	8 Lamp - 32W T8
Lumen Per Watt	138	136	139
Color Accuracy (CRI)	>80	>80	>80
Working Temperature	-4-104°F (-20-40°C)	-4-104°F (-20-40°C)	-4-104°F (-20-40°C)
IP Rating	IP20 Rated	IP20 Rated	IP20 Rated

■ **Dimensions & Weight**

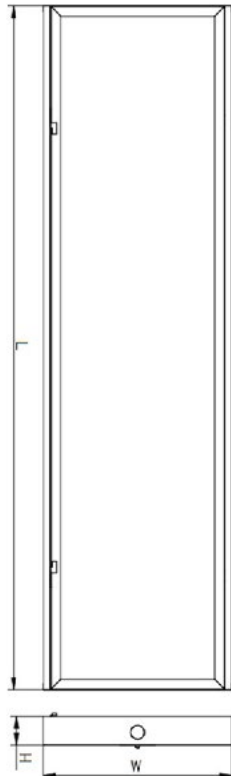

120W, 150W

Length: 47.24"
Width: 13.78"
Height: 2"
Max. Weight: 15.21 lbs

185W

Length: 47.24"
Width: 19.7"
Height: 2"
Max. Weight: 20.01 lbs

■ **Application**



Ordering Information

Example: LHB120501MSO-82

Linear High Bay	Watts	CCT	Voltage	Controls	Beam Angle
LHB	120 - 120 Watts	35 - 3500K	1 - 120-277 V	MS - Motion Sensor	82 - 82°
	150 - 150 Watts	40 - 4000K	6 - 347/480V	MSO - ON/OFF Motion Sensor	
	185 - 185 Watts	50 - 5000K		EBU - Emergency Battery Backup ¹	

Notice:

1. The working temperature of fixture with EBU is 32-104°F.

* Standard Finish as White. Special Order as other finish color - Please Ask Customer Service for Details.

Accessories Information (Order Separately)



LHB-CLEAR-S (For 120W&150W)
LHB-CLEAR-L (For 185W)
 Clear Lens including frame for Linear High Bay



LHB 120V Plug and Cord
 120V molded plug and cord for LHB with pipe clamp for strain relief



LHB-FROSTED-S (For 120W&150W)
LHB-FROSTED-L (For 185W)
 Frosted Lens including frame for Linear High Bay



LHB 277V Plug and Cord
 277V molded plug and cord for LHB with pipe clamp for strain relief



LHB-WG-S (For 120W&150W)
LHB-WG-L (For 185W)
 Wire Guard for Linear High Bay

Photometry

All published luminaire photometric testing performed to IESNA LM-79-08 standards by a NVLAP certified laboratory.

Mounting Height	10	12	15	18	20	25	33
Multiplier	10.9	7.6	4.9	3.4	2.8	1.8	1

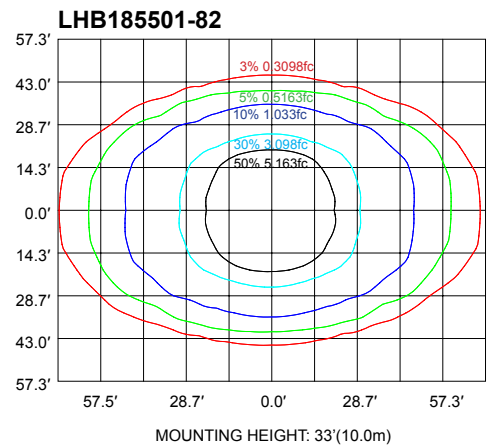
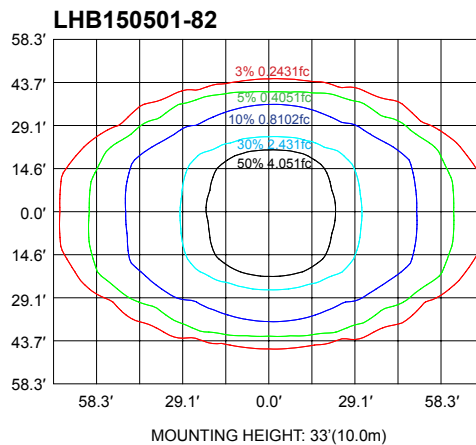
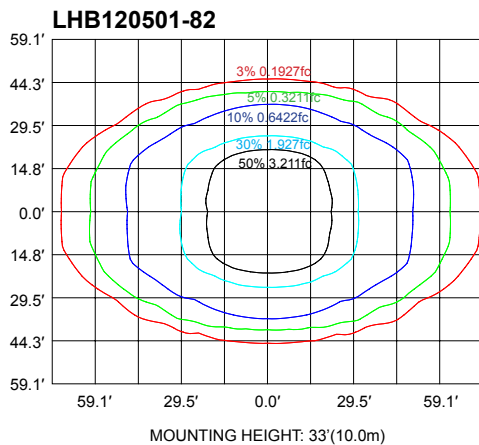

Note: Please visit our website for more details.





■ **FEATURES**

1. Wide lumen package from 9000lm to 60,000lm
2. Superior thermal management leads to longer life and enhanced performance
3. Maximum 150 F high ambient
4. General, narrow, and medium distributions available to meet both horizontal & vertical light level requirements
5. Various mounting options
6. Wireless control unit option provides superior lighting management capability including remote & programmed control, individual fixture control or zonal control network for increasing energy saving
7. Multi-level motion sensor, emergency battery backup available
8. 10kV surge suppression protection optional

■ **Performance**

Input Watts (LM-79 Reported)	65	95	135	175	220
Input Voltage	120-277	120-277	120-277	120-277	120-277
Output Lumens (@5000K)	9100	13300	18900	24500	30360
Lumen Per Watt	140	140	140	140	138
Color Accuracy (CRI)	80	80	80	80	80
Length	2FT	2FT	2FT	2FT	2FT
Working Temperature	-4-149°F (-20-65°C)	-4-149°F (-20-65°C)	-4-149°F (-20-65°C)	-4-149°F (-20-65°C)	-4-140°F (-20-60°C)
IP Rating	IP20 Rated	IP20 Rated	IP20 Rated	IP20 Rated	IP20 Rated
Input Watts (LM-79 Reported)	220	270	350	440	
Input Voltage	120-277	120-277	120-277	120-277	
Output Lumens (@5000K)	30800	37800	49000	60720	
Lumen Per Watt	140	140	140	138	
Color Accuracy (CRI)	80	80	80	80	
Length	4FT	4FT	4FT	4FT	
Working Temperature	-4-149°F (-20-65°C)	-4-149°F (-20-65°C)	-4-149°F (-20-65°C)	-4-140°F (-20-60°C)	
IP Rating	IP20 Rated	IP20 Rated	IP20 Rated	IP20 Rated	

■ **Dimensions & Weight**

2FT HLHB (Without MS)	2FT HLHB (With MSO)	4FT HLHB (Without MS)	4FT HLHB (With MSO)
L1: 24"	L1: 24"	L1: 45.5"	L1: 45.5"
W: 16.25"	L2: 4.92"	W: 16.25"	L2: 4.92"
H: 3.15"	W: 16.25"	H: 3.15"	W: 16.25"
	H: 3.15"		H: 3.15"

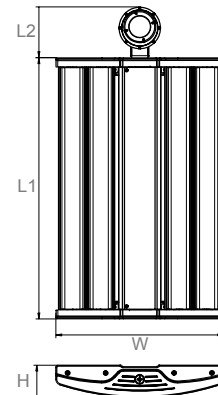

■ **Installation**

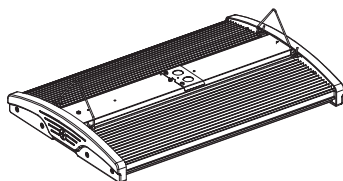

V Hook Mounting

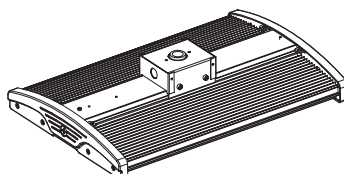

Pendant Mounting

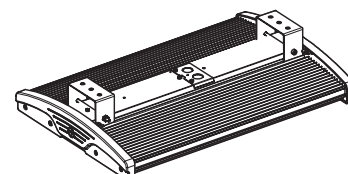

Channel Mounting

Ordering Information

Example: HLHB02-175501-G-AFL

Series	Length	Watts	CCT	Voltage	Controls	Distribution	LENS
HLHB	02 - 2FT ¹	65 - 65 Watts	35-3500K	1-120V-277V	MS-L7W - Motion Sensor with White L7 Lens	G - General	AFL - Acrylic
	04 - 4FT ²	95 - 95 Watts	40-4000K	3 - 480V		N - Narrow	Frosted ⁴
		135 - 135 Watts	50-5000K	6 - 347/480V	M - Medium	ACL - Acrylic	
		175 - 175 Watts				Clear ⁵	
		220 - 220 Watts ⁶				PCL - Clear	
		270 - 270 Watts				Polycarbonate	
		350 - 350 Watts					
	440 - 440 Watts ⁷				EBU - Emergency Battery Backup ³		

Notice:



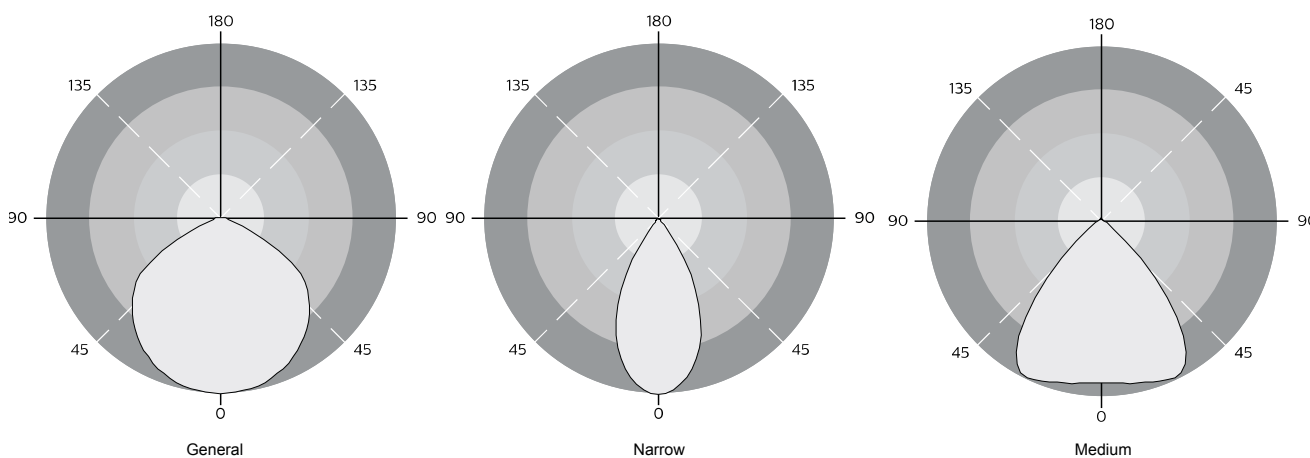

- 2FT HLHB is only available from 65W to 220W
- 4FT HLHB is only available from 220W to 440W
- Emergency battery backup available in 10W with 1300lm @ 120-277V. For ambient temperatures of 32°F-104°F(0°C-40°C) The emergency test button is pre-installed on fixture.
- Acrylic frosted lens is not available with Narrow and Medium distribution
- Acrylic clear lens is not available with Narrow and Medium distribution
- Maximum ambient temperature of 220W 2FT HLHB is 140°F(60°C)
- Maximum ambient temperature of 440W 4FT HLHB is 140°F(60°C)
- Microwave Dimming Sensor is NOT available for 440W

Photometry

All published luminaire photometric testing performed to IESNA LM-79-08 standards by a NVLAP certified laboratory.

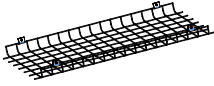
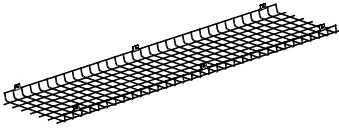
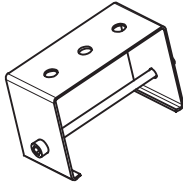
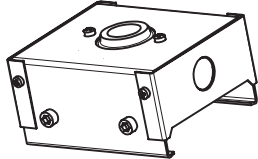

■ Accessories Information (Order Separately)

SKU	MODEL	IMAGE	DESCRIPTION
90205	HLHB02-WG		Wire guard for 2ft heavenly linear high bay
90206	HLHB04-WG		Wire guard for 4ft heavenly linear high bay
90207	HLHB-CMK		Channel mounting kits for heavenly linear high bay
90208	HLHB-PMK		Pendant mounting kits for heavenly linear high bay
N/A	V-clip		V-clip mounting kits for heavenly linear high bay ¹
90097	LHB 277V Plug and Cord		277V molded plug and cord for LHB with pipe clamp for strain relief
90098	LHB 277V Plug and Cord		277V molded plug and cord for LHB with pipe clamp for strain relief

Notice:

1. V-clip mounting kits is for standard mounting and shipped together. All the other Accessories need to be ordered separately.



↑ Patient Rooms 221-233 ↑

← EXIT

CHILDREN'S HOSPITAL →
WOMENS HOSPITAL →

↑ Patient Rooms 221-233 ↑

EXIT

EXIT

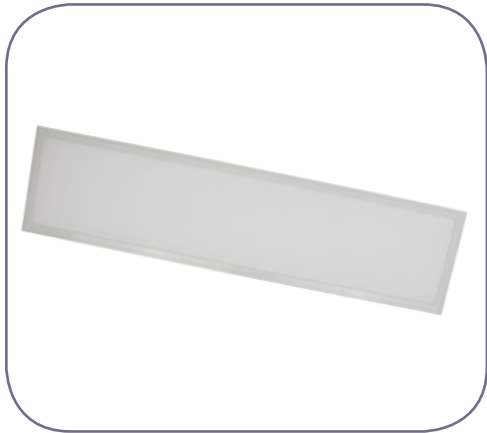

■ FEATURES

1. TOP 5 LED Chip
2. Standard 1-10V Dimming
3. EBU Backup Available
4. PMMA Light Transmitter

■ Performance

Input Watts (LM-79 Reported)	41
Input Voltage	120-277
Output Lumens (@3000K)	4693
Replaces (FL)	2x32W FL
Lumen Per Watt	112
Color Accuracy (CRI)	>80
Working Temperature	-4-104°F (-20-40°C)
IP Rating	IP20 Rated

■ Dimensions & Weight

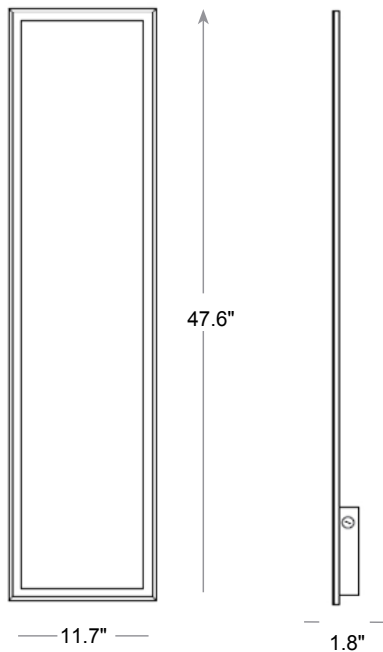

1X4

Length: 11.7"

Width: 47.6"

Height: 1.8"

Max. Weight: 11 lbs

■ Accessories Information (Order Separately)



FLP 1*4 Surface Mount Kit
1*4 Flat Panel Accessories

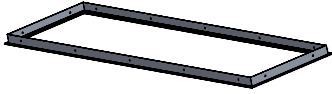

FLP 1*4 Flange Kit
1*4 Flat Panel Recessed Mount Kit

■ Ordering Information Example: FLP14D3835

Flat LED Panel	Dimention	Dimmable	Watts	CCT	EBU
FLP	14 - 11.7" x 47.6"	D - 1-10V dimming	38 - 38W	30 - 3000K 35 - 3500K 40 - 4000K 50 - 5000K	EBU - Emergency Battery Back-up ¹

Notice:

1. The working temperature of fixture with EBU is 32-104°F.

* Standard Finish as White. Special Order as other finish color - Please Ask Customer Service for Details.

■ Photometry

All published luminaire photometric testing performed to IESNA LM-79-08 standards by a NVLAP certified laboratory.

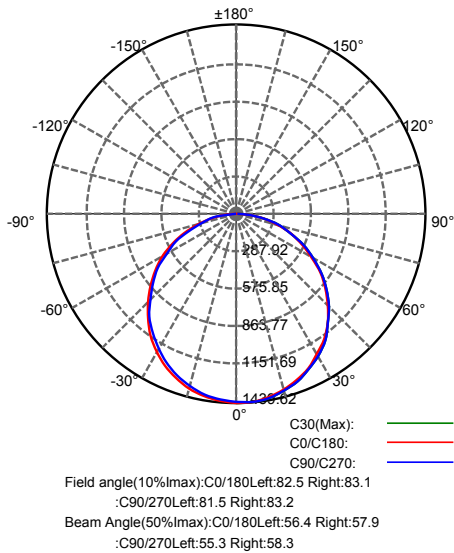

Note: Please visit our website for more details.



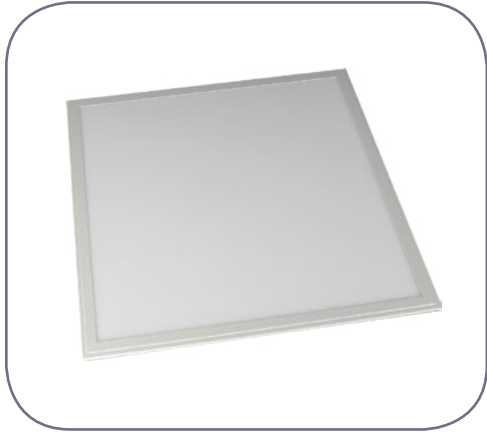

■ **FEATURES**

1. TOP 5 LED Chip
2. Standard 1-10V Dimming
3. EBU Backup Available
4. PMMA Light Transmitter

■ **Performance**

Input Watts (LM-79 Reported)	41
Input Voltage	120-277
Output Lumens (@3000K)	4770
Replaces (FL)	3x17W FL
Lumen Per Watt	114
Color Accuracy (CRI)	>80
Working Temperature	-4-104°F (-20-40°C)
IP Rating	IP20 Rated

■ **Dimensions & Weight**

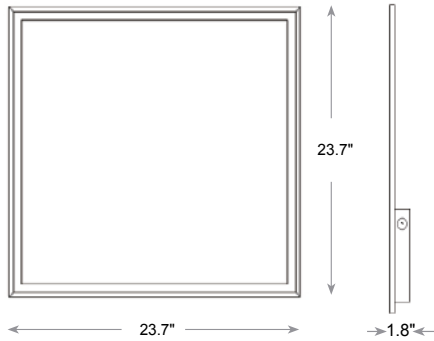

2X2
 Length: 23.7"
 Width: 23.7"
 Height: 1.8"
 Max. Weight: 9.7 lbs

■ **Application**



■ Accessories Information (Order Separately)



FLP 2*2 Surface Mount Kit
2*2 Flat Panel Accessories

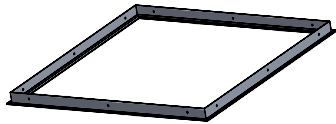

FLP 2*2 Flange Kit
2*2 Flat Panel Recessed Mount Kit

■ Ordering Information Example: FLP22D3835

Flat LED Panel	Dimention	Dimmable	Watts	CCT	EBU
FLP	22 - 23.7" x 23.7"	D - 1-10V dimming	38 - 38W	30 - 3000K 35 - 3500K 40 - 4000K 50 - 5000K	EBU - Emergency Battery Back-up ¹

Notice:

1. The working temperature of fixture with EBU is 32-104°F.

* Standard Finish as White. Special Order as other finish color - Please Ask Customer Service for Details.

■ Photometry

All published luminaire photometric testing performed to IESNA LM-79-08 standards by a NVLAP certified laboratory.

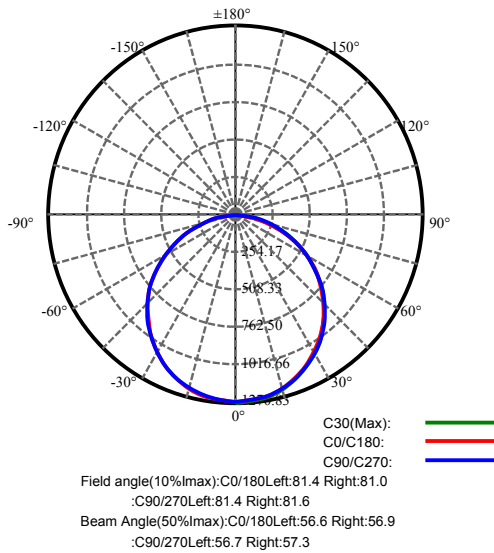

Note: Please visit our website for more details.





■ **FEATURES**

1. TOP 5 LED Chip
2. Standard 1-10V Dimming
3. EBU Backup Available
4. PMMA Light Transmitter

■ **Performance**

Input Watts (LM-79 Reported)	33	52
Input Voltage	120-270	120-277
Output Lumens (@3000K)	3661	5861
Replaces (FL)	3x32W FL or 4x32W FL	3x32W FL or 4x32W FL
Lumen Per Watt	111	113
Color Accuracy (CRI)	>80	>80
Working Temperature	-4-104°F (-20-40°C)	-4-104°F (-20-40°C)
IP Rating	IP20 Rated	IP20 Rated

■ **Dimensions & Weight**

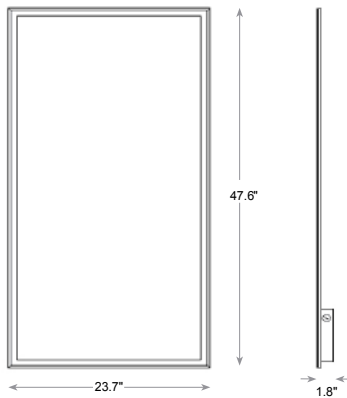

2X4
 Length: 23.7"
 Width: 47.6"
 Height: 1.8"
 Max. Weight: 20.3 lbs

■ **Application**

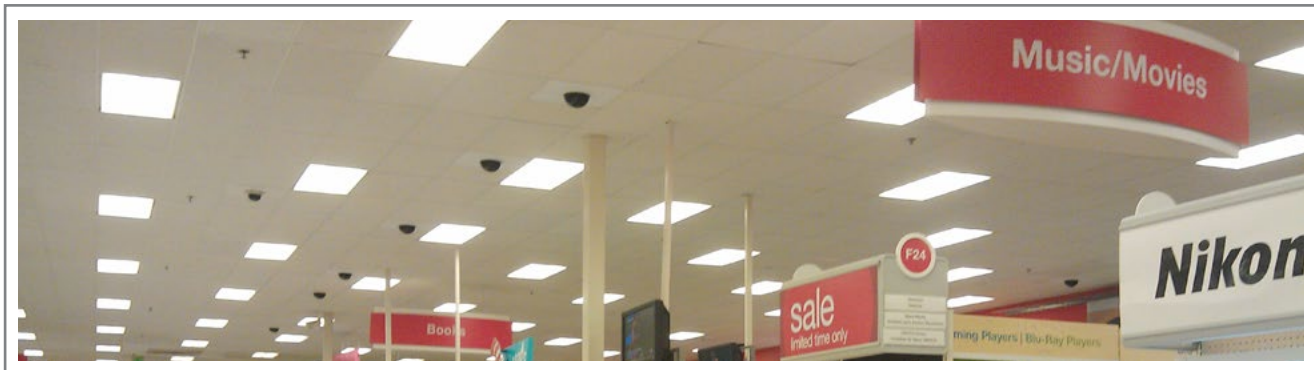

■ Accessories Information (Order Separately)



FLP 2*4 Surface Mount Kit
2*4 Flat Panel Accessories

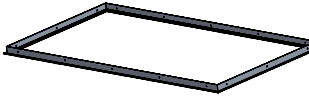

FLP 2*4 Flange Kit
2*4 Flat Panel Recessed Mount Kit

■ Ordering Information Example: FLP24D5335

Flat LED Panel	Dimention	Dimmable	Watts	CCT	EBU
FLP	24 - 23.7" x 47.6"	D - 1-10V dimming	38 - 35 W 53 - 53W	30 - 3000K 35 - 3500K 40 - 4000K 50 - 5000K	EBU - Emergency Battery Back-up ¹

Notice:

1. The working temperature of fixture with EBU is 32-104°F.

* Standard Finish as White. Special Order as other finish color - Please Ask Customer Service for Details.

■ Photometry

All published luminaire photometric testing performed to IESNA LM-79-08 standards by a NVLAP certified laboratory.

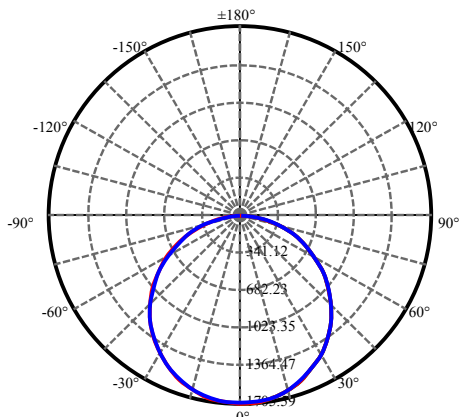

C0(Max): —
 C0/C180: —
 C90/C270: —
 Field angle(10%Imax):C0/180Left:82.4 Right:82.9
 :C90/270Left:82.1 Right:83.2
 Beam Angle(50%Imax):C0/180Left:56.6 Right:57.4
 :C90/270Left:56.5 Right:57.5

Note: Please visit our website for more details.





• LET'S
Start





■ **FEATURES**

1. DLC Premium
2. Center basket design
3. Universal 120-277V
4. 1-10V dimming
5. EBU, sensor as the options

■ **Performance**

Input Watts	25	35	45
Input Voltage	120-277	120-277	120-277
Output Lumens (@5000K)	3250	4375	5850
Replaces (FL)	3 F17T8	4 F17T8	4 F32T8
Lumen Per Watt	130	125	130
Color Accuracy (CRI)	>80	>80	>80
Working Temperature	-4-104°F (-20-40°C)	-4-104°F (-20-40°C)	-4-104°F (-20-40°C)
IP Rating	IP20 Rated	IP20 Rated	IP20 Rated

■ **Dimensions**

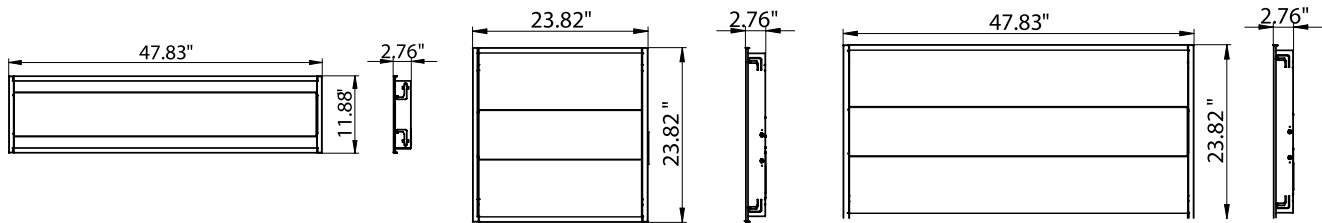

1x4
Max. Weight: 6.19lbs

2x2
Max. Weight: 8.66lbs

2x4
Max. Weight: 14.04lbs

■ **Application**



DLC P LED Center Basket Troffer

Ordering Information Example: TR22D25LED30- SP-EBU

Center Basket Troffer	Size	Dimmable	Watts	LED	CCT	Series	Control
TR	14 - 1x4 FT	D - 1-10V	25 - 25 Watts	LED	35 - 3500K	SP – SP series	Blank - None
		Dimmable	35 - 35 Watts		40 - 4000K		MSW - Microwave Motion Sensor
					50 - 5000K		
	22 - 2x2 FT		25 - 25 Watts			EBU - Emergency Battery Back-up ¹	
			35 - 35 Watts				
	24 - 2x4 FT		25 - 25 Watts				
		35 - 35 Watts					
		45 - 45 Watts					

Notice:

- Emergency battery backup is available for 2x2 and 2x4 NOT including 1x4. And the working temperature is 32-104°F. The emergency test button is pre-installed on fixture. If need a remote test switch please contact factory.
- Standard Finish is White.
- 35W 4000K will be in stock.
- Special Order as other finish color - Ask Customer Service for Details.

Photometry

All published luminaire photometric testing performed to IESNA LM-79-08 standards by a NVLAP certified laboratory.

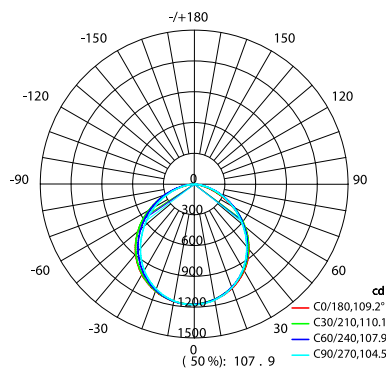

1x4

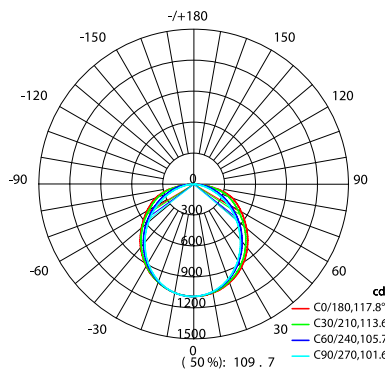

2x2

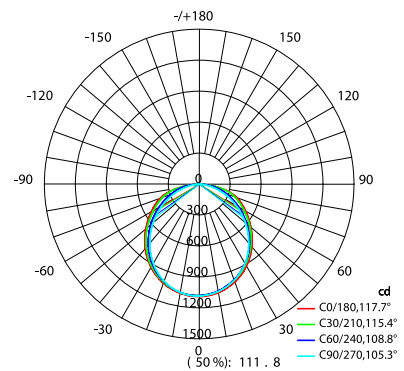

2x4

Note: Please visit our website for more details.





■ FEATURES

1. Designed to Retrofit Fluorescent Troffer
2. Quick and Easy Installation
3. EBU Backup Available

■ Performance

Input Watts	18	26	32
Input Voltage	120-277	120-277	120-277
Output Lumens (@4000K)	2044	3348	3751
Replaces (FL)	2 F17T8	3 F17T8	4 F17T8
Lumen Per Watt	112	131	116
Color Accuracy (CRI)	>80	>80	>80
Working Temperature	-4-104°F (-20-40°C)	-4-104°F (-20-40°C)	-4-104°F (-20-40°C)
IP Rating	IP20 Rated	IP20 Rated	IP20 Rated

■ Dimensions & Weight

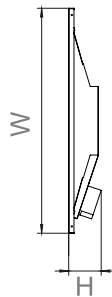
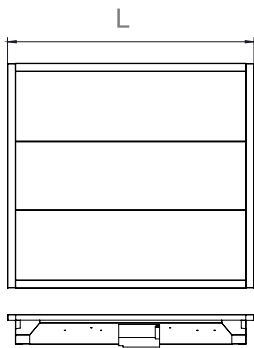

2X2

Length: 22.56"

Width: 20.59"

Height: 2.97"

Max. Weight: 12 lbs

■ Application

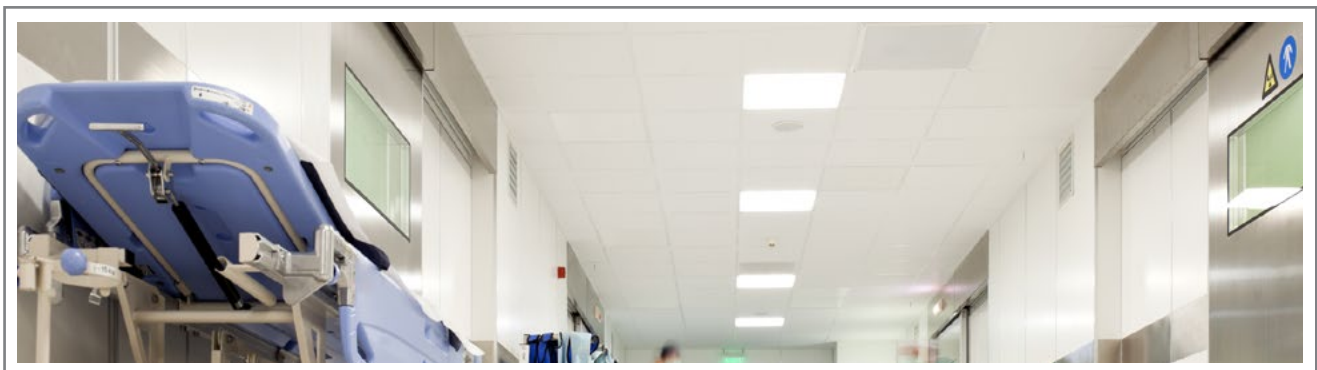

DLC P LED Troffer Retrofit Kit 2'x2' DL Series

Ordering Information

Example: TRK22D25LEDXX-DL-EBU

TROFFER RETROFIT KIT	Dimension	Dimmable	Watts	Source type	CCT	Series	Control
TRK	22 - 2'x2'	D - 1-10V Dimmable	18 - 18 Watts ¹	LED	30 - 3000K	Series - DL	MSW - Microwave motion sensor EBU - Emergency Battery Backup ⁴
			25 - 25 Watts ²		35 - 3500K		
			32 - 32 Watts ³		40 - 4000K		
					50 - 5000K		

Notice:

- All colors for 18W is DLC Standard qualified.
 - All colors except 3000K for 25W is DLC Premium qualified.
 - No DLC listing at present.
 - The working temperature of fixture with EBU is 32-104°F.
- * Standard Finish as White. Special Order as other finish color - Please Ask Customer Service for Details.

Photometry

All published luminaire photometric testing performed to IESNA LM-79-08 standards by a NVLAP certified laboratory.

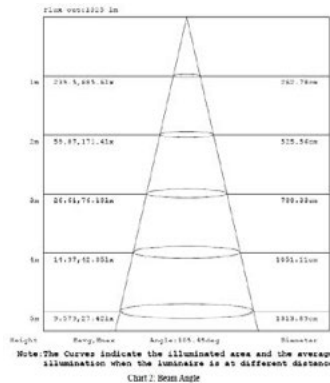
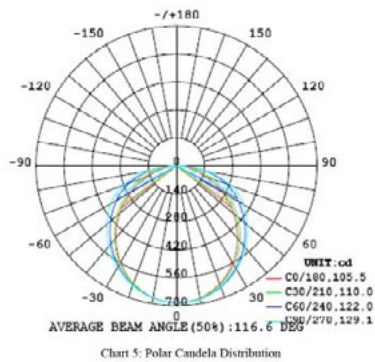

18W

Note: Please visit our website for more details.





■ **FEATURES**

1. Designed to Retrofit Fluorescent Troffer
2. Quick and Easy Installation
3. EBU Backup Available

■ **Performance**

Input Watts	25	36	44
Input Voltage	120-277	120-277	120-277
Output Lumens (@3500K)	3345	4464	5074
Replaces (FL)	2 F32T8	3 F32T8	4 F32T8
Lumen Per Watt	1303>80	124	118
Color Accuracy (CRI)	-4-104°F (-20-40°C)	>80	>80
Working Temperature	IP20 Rated	-4-104°F (-20-40°C)	-4-104°F (-20-40°C)
IP Rating		IP20 Rated	IP20 Rated

■ **Dimensions & Weight**

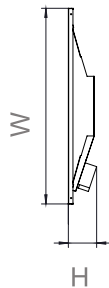
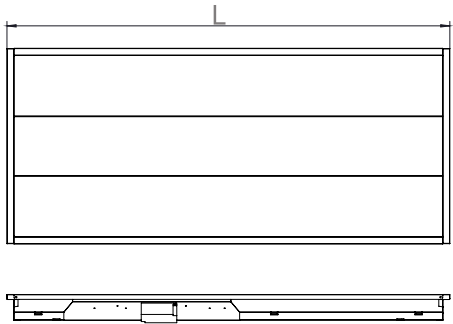

2X4

- Length: 46.62"
- Width: 20.59"
- Height: 2.97"
- Max. Weight: 21 lbs

■ **Application**



DLC P LED Troffer Retrofit Kit 2'x4' DL Series

Ordering Information Example: TRK24D25LEDXX-DL-EBU

TROFFER RETROFIT KIT	Dimension	Dimmable	Watts	Source type	CCT	Series	Control
TRK	24 - 2'x4'	D - 1-10V Dimmable	25 - 25 Watts ¹	LED	30 - 3000K	Series - DL	MSW - Microwave Motion Sensor
			38 - 38 Watts ²		35 - 3500K		
			45 - 45 Watts ³		40 - 4000K		
					50 - 5000K		

Notice:

1. All colors except 3000K for 25W is DLC Premium qualified.
 2. All colors for 38W are DLC standard qualified
 3. All colors for 45W are DLC standard qualified
 4. 45W is unavailable in EBU solution. And the working temperature of fixture with EBU is 32-104°F.
- * Standard Finish as White. Special Order as other finish color - Please Ask Customer Service for Details.

Photometry

All published luminaire photometric testing performed to IESNA LM-79-08 standards by a NVLAP certified laboratory.

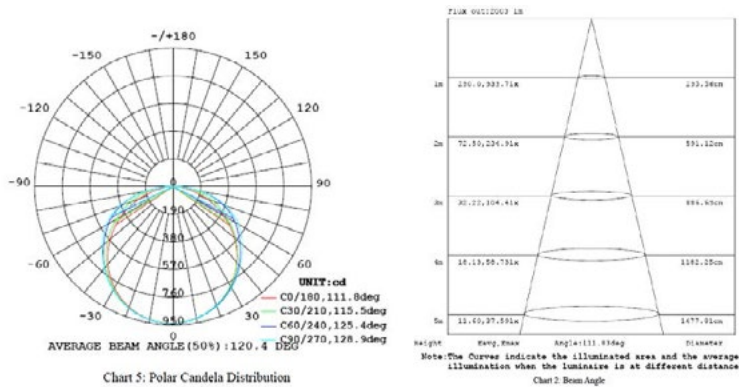

25W

Note: Please visit our website for more details.





■ **FEATURES**

1. Top 5 LED Chip & LED Driver
2. Clear PMMA Diffuser Lens
3. EBU Backup Available

■ **Performance**

Input Watts (LM-79 Reported)	28 @2FT	38 @4FT
Input Voltage	120-277	120-277
Output Lumens (@5000K)	3640	4940
Replaces (FL)	2 Lamp - 17W T8	2 Lamp - 32W T8
Lumen Per Watt	130	130
Color Accuracy (CRI)	80	80
Working Temperature	-4-104°F (-20-40°C)	-4-104°F (-20-40°C)
IP Rating	IP20 Rated	IP20 Rated

■ **Dimensions & Weight**

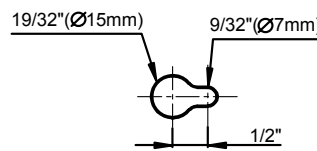
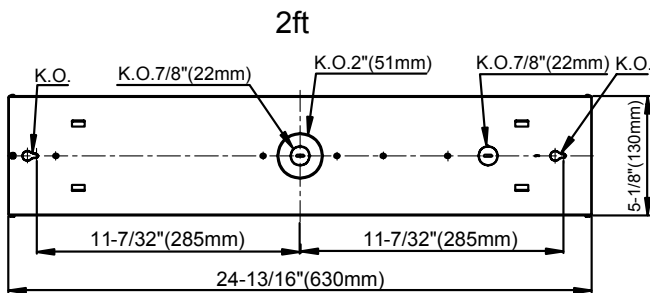

2FT

Length: 25.01"
Width: 5.12"
Height: 3.03"
Max. Weight: 3.7lbs

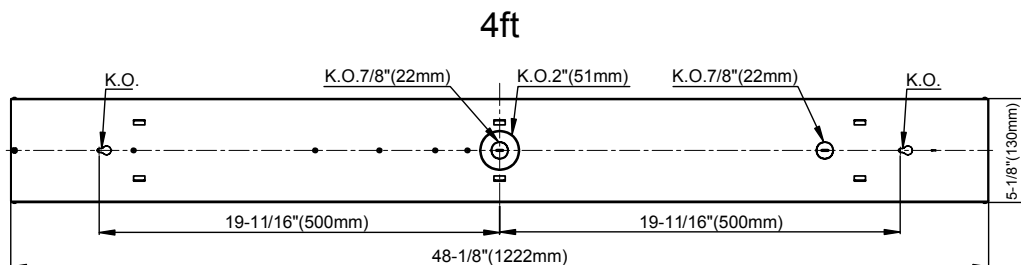

4FT

Length: 48.11"
Width: 5.12"
Height: 3.03"
Max. Weight: 6.6 lbs

■ Application

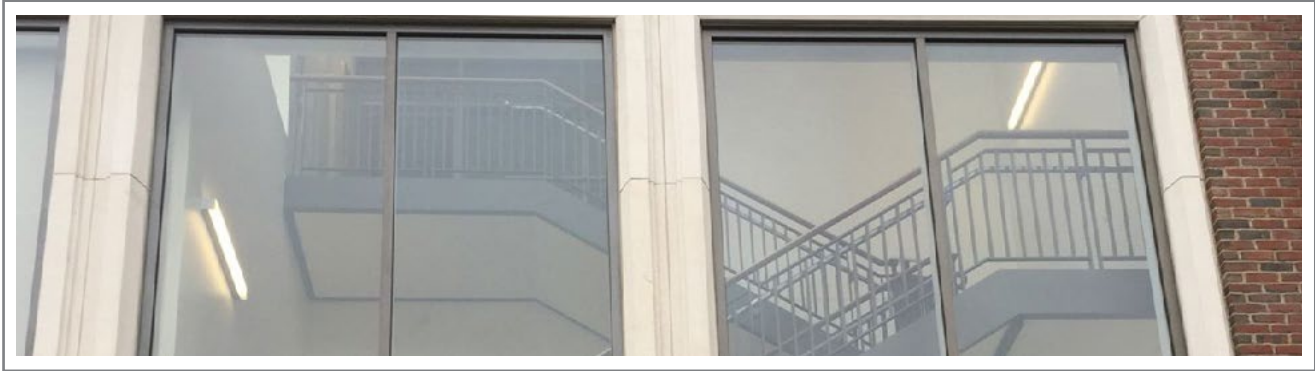

■ Ordering Information Example: WRP06D28LED301S-MSW

Wrap Fixture	Dimension	Dimmable	Watts	LED	CCT	Voltage	Series	Controls
WRP	06 - 2FT	D - 0-10V dimmable	28 - 28 Watts	LED	30 - 3000K	1 - 120-277V	S - STD series	Blank - None MSWO - Microwave ON/OFF Sensor ¹ MSW - Microwave Dimming Sensor ²
	12 - 4FT		38 - 38 Watts		35 - 3500K			

Notice:

1. Microwave ON/OFF sensor, for mounting height 20ft (6m) max. It is standard.
 2. Microwave dimming sensor, for mounting height 49ft (15m) max. It is for option.
- Please contact customer service in advance.
 * Special Order- Ask Customer Service for Details

■ Photometry

All published luminaire photometric testing performed to IESNA LM-79-08 standards by a NVLAP certified laboratory.

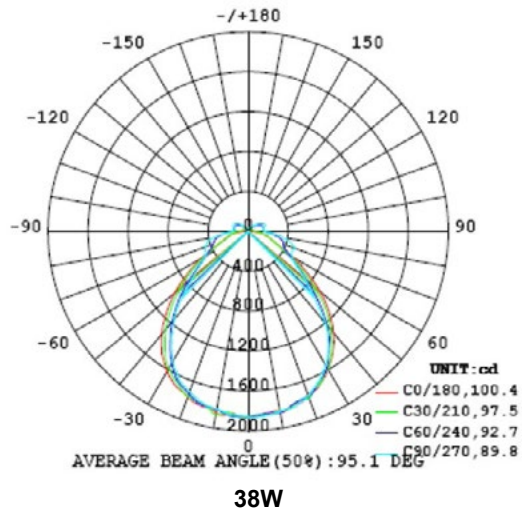
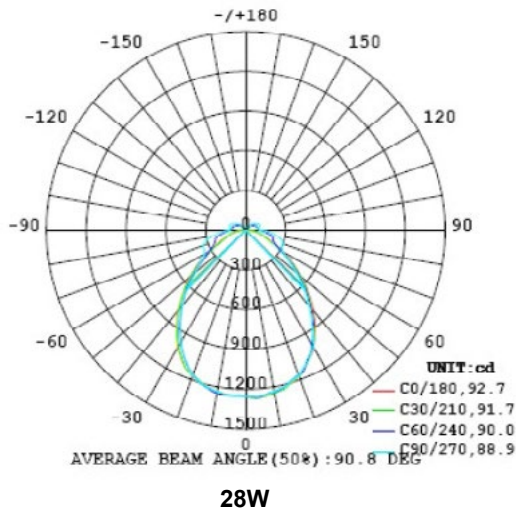

Note: Please visit our website for more details.



ires INTEGRATING RESEARCH EXPERIENCES IN SCIENCE **HST** HARVARD SCHOOL OF HEALTH CARE **MIT** MASSACHUSETTS INSTITUTE OF TECHNOLOGY

Graduate Education in Medical Sciences (GEMS)

A certificate program for PhD students in the School of Engineering or School of Science

Are you interested in...

- Learning how your research is relevant to **MEDICINE?**
- Having **CLINICAL EXPERIENCES** where engineering and science meet real world health care?
- Professional networking in the **HARVARD MEDICAL COMMUNITY?**
- Exploring ideas for **MEDICALLY-RELEVANT THESIS RESEARCH?**
- Pursuing **MEDICAL POST-DOC OPPORTUNITIES?**
- Creating a **BIOMEDICAL BUSINESS?**

LEARN MORE
HST.MIT.EDU/GEMS

INFO SESSION
Friday, October 28th
3 – 4 pm, E25-401

APPLICATION DEADLINE
Friday, November 18

October 28, 2019 01:11 PM

tech tech
tech tech
tech







■ **FEATURES**

1. 4 Feet And 8 Feet
2. Cold-Rolled Steel Body
3. EBU Backup Available
4. Wire Guard Is For Option

■ **Performance**

Input Watts	20 @2FT	40 @4FT	85 @8FT
Input Voltage	120-277	120-277	120-277
Output Lumens (@4000K)	2200	4400	9350
Replaces (FL)	2 Lamp - 17W T8	2 Lamp - 32W T8	4 Lamp - 32W T8
Lumen Per Watt	110	110	110
Color Accuracy (CRI)	80	80	>80
Working Temperature	-4-104°F (-20-40°C)	-4-104°F (-20-40°C)	-4-104°F (-20-40°C)
IP Rating	IP20 Rated	IP20 Rated	IP20 Rated

■ **Dimensions & Weight**

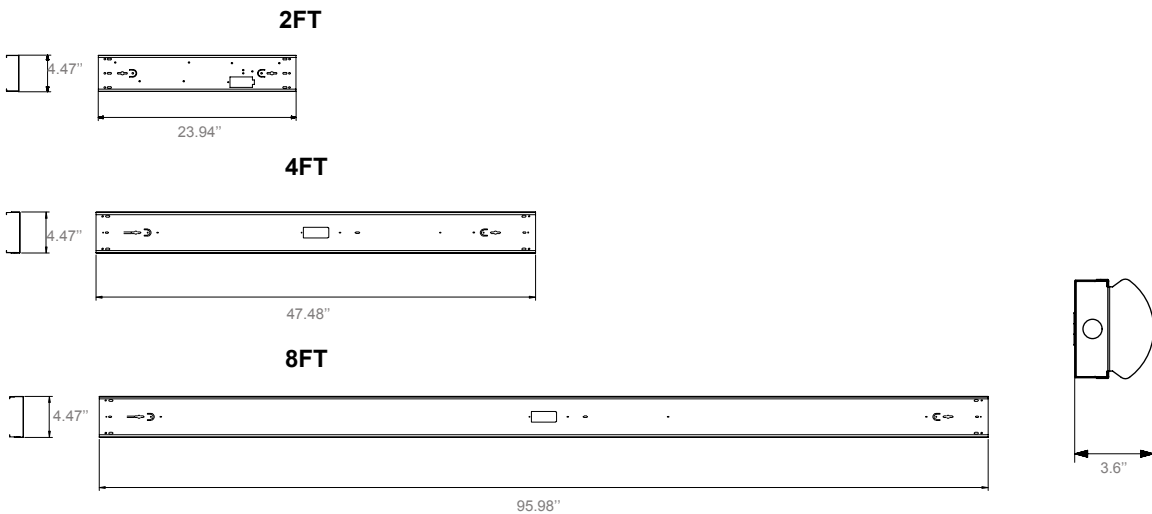

2FT

Length: 23.94"
Width: 4.47"
Height: 3.60"
Max. Weight: 2.0 lbs

4FT

Length: 47.48"
Width: 4.47"
Height: 3.60"
Max. Weight: 3.50 lbs

8FT

Length: 95.98"
Width: 4.47"
Height: 3.60"
Max. Weight: 7.50 lbs

Ordering Information Example: STR12D40LED401S

STRIP Fixture	Dimension	Dimmable	Watts	LED	CCT	Voltage	Series	Options
STR	06 - 2FT	D - 0-10V	20 - 20 Watts	LED	30 - 3000K	1 - 120-277V	S - STD series	Blank - None
	12 - 4FT	Dimmable	40 - 40 Watts		35 - 3500K			MSWO - Microwave ON/OFF Sensor ¹
	24 - 8FT		85 - 80 Watts		40 - 4000K	MSW-Microwave Dimming sensor ²		
					50 - 5000K	EBU - Emergency Battery Back-up ³		
								WG - Wire Guard

1. Microwave ON/OFF sensor, for mounting height 20ft (6m) max. It is standard.
 2. Microwave dimming sensor, for mounting height 49ft (15m) max. It is for option. Please contact customer service in advance.
 3. The emergency test button is pre-installed on fixture. If need a remote test switch please contact factory.
- *Special Order- Ask Customer Service for Details

Photometry

All published luminaire photometric testing performed to IESNA LM-79-08 standards by a NVLAP certified laboratory.

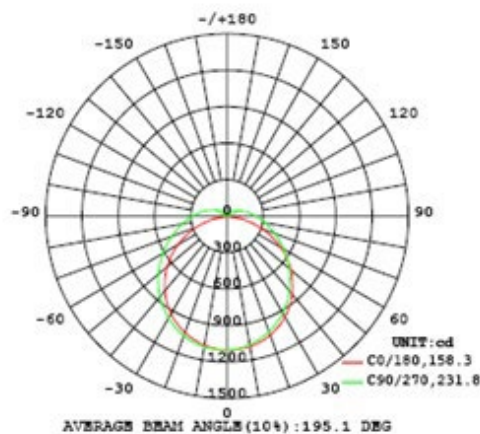

40W 4000K

Note: Please visit our website for more details.





■ FEATURES

1. Replacements for incandescent and compact fluorescent (CFL) light sources
2. CREE LED chip is used
3. Die-cast aluminum heat sink for maximum heat dissipation
4. TRIAC dimming (at 120V only)
5. ENERGY STAR® Version 2.0 Certified
6. Retrofit E26 base and connector are available

■ Performance

Input Watts (Based on Energy Star)	15
Input Voltage	120V
Output Lumens (@3000K)	1100
Replaces (Inc)	75W incandescent
Lumen Per Watt	75
Color Accuracy (CRI)	>80
Working Temperature	-4-104°F (-20-40°C)
IP Rating	IP20 Rated

■ Dimensions & Weight

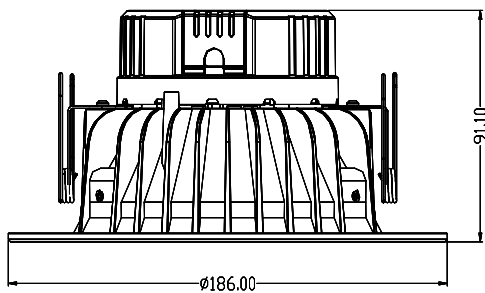

Depth: 91.1mm / 3.59"
 Diameter: 186mm / 7.30"
 Max. Weight: 1.1 lbs

■ Application

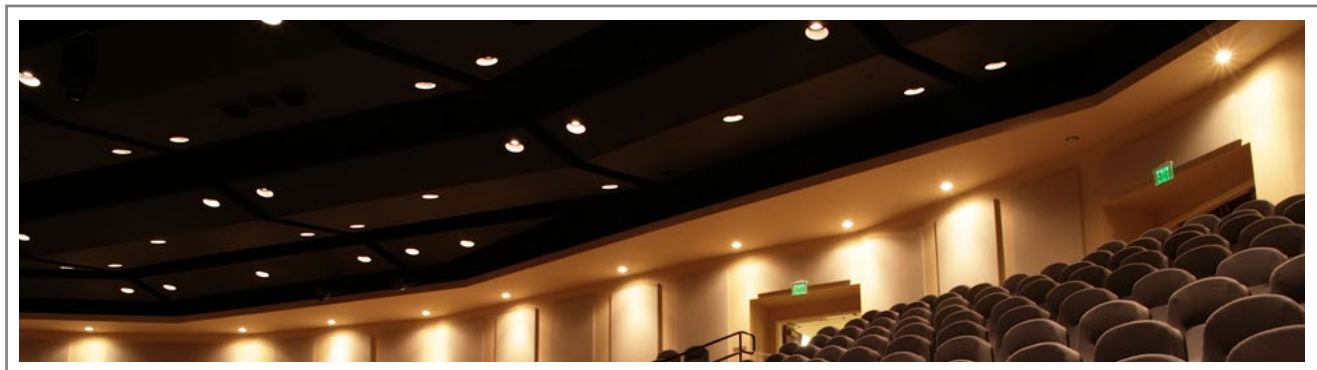

Commercial Downlight Retrofit Kit 6 Inch

Ordering Information Example: DL1530-6

Downlight	Watts	CCT	Dimension
DL	15 - 15 Watts	30 - 3000K	6 - 6"

Notice:

* Standard Finish as White. Special Order as other finish color -Please Ask Customer Service for Details.

Photometry

All published luminaire photometric testing performed to IESNA LM-79-08 standards by a NVLAP certified laboratory.

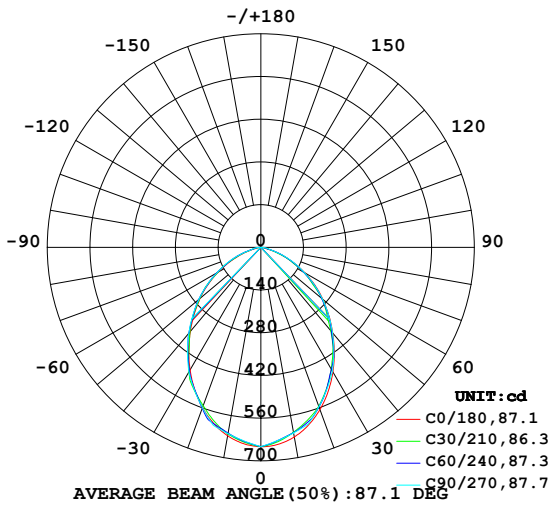

Note: Please visit our website for more details.





■ **FEATURES**

1. Replacements for incandescent and compact fluorescent (CFL) light sources
2. CREE LED chip and Mean Well LED driver are used
3. Die-cast aluminum heat sink for maximum heat dissipation
4. Universal dimming driver for 1-10V (at 120-277V)
5. ENERGY STAR® Version 2.0 Certified

■ **Performance**

Input Watts (Based on Energy Star)	30 (6 inch)	40 (8 inch)
Input Voltage	120-277V	120-277V
Output Lumens (@3000K)	2200	3300
Replaces (HID)	100W HID	150W HID
Lumen Per Watt	85	85
Color Accuracy (CRI)	>80	>80
Working Temperature	-4-104°F (-20-40°C)	-4-104°F (-20-40°C)
IP Rating	IP20 Rated	IP20 Rated

■ **Dimensions & Weight**

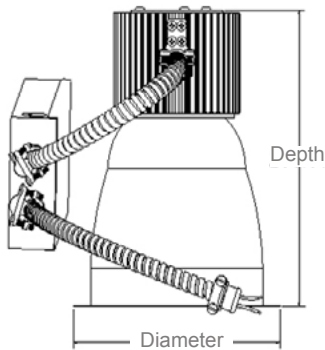

6 Inch (30W)

Depth: 235mm / 9.25"
 Diameter: 180mm / 7.09"
 Max. Weight: 4.59 lbs

8 Inch (40W)

Depth: 265mm / 10.43"
 Diameter: 230mm / 9.06"
 Max. Weight: 4.92 lbs

■ **Application**

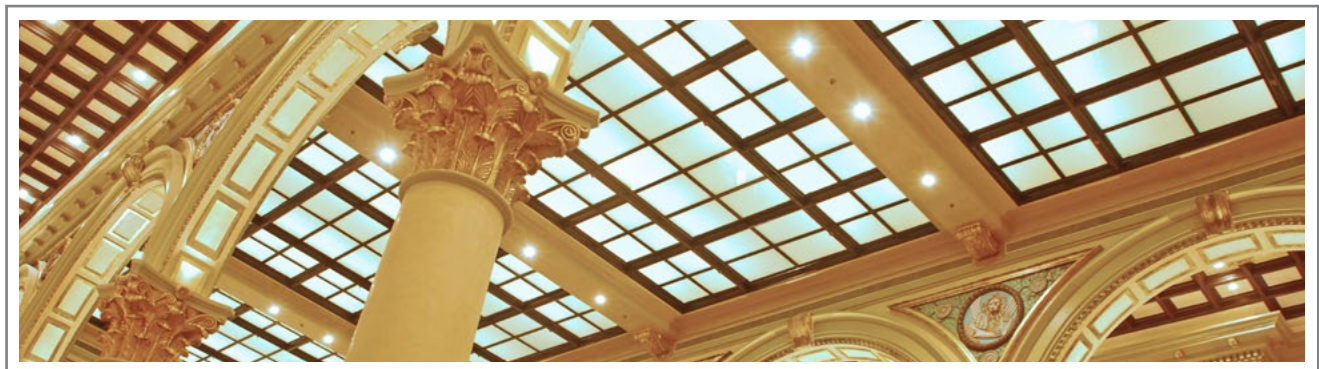

Commercial Downlight Retrofit Kit 6 Inch & 8 Inch

Ordering Information Example: DL3030-6

Downlight	Watts	CCT	Dimension
DL	30 - 30 Watts	30 - 3000K	6 - 6" (Only 30W)
	40 - 40 Watts		8 - 8" (Only 40W)

Notice:

* Standard Finish as Silver. Special Order as other finish color - Please Ask Customer Service for Details.

Photometry

All published luminaire photometric testing performed to IESNA LM-79-08 standards by a NVLAP certified laboratory.

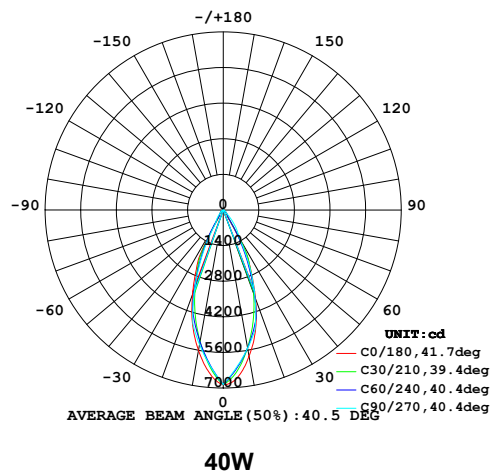
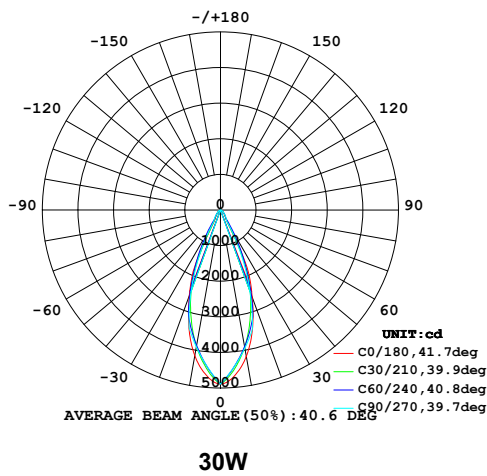

Note: Please visit our website for more details.





■ **FEATURES**

1. External driver, much reliable and convenient.
2. 0-10V dimming can be used with more controls.
3. Rebate-qualified product with high ROI.
4. Title 24 compliance and high efficiency, up to 130LPW.

■ **Performance**

Input Watts	10W (with one tube)	20W (with two tube)	30W (with three tube)	40W (with four tube)
Input Voltage	120-277V	120-277V	120-277V	120-277V
Output Lumens(@5000K)	1300lm	2600lm	3900lm	5200lm
Replaces (FL)	1F17T8(2FT)	2F17T8(2FT)	3F17T8(2FT)	4F17T8(2FT)
Lumen Per Watt	130	130	130	130
Color Accuracy (CRI)	>80	>80	>80	>80
Working Temperature	-4-104°F (-20-40°C)	-4-104°F (-20-40°C)	-4-104°F (-20-40°C)	-4-104°F (-20-40°C)
IP Rating	IP20 Rated	IP20 Rated	IP20 Rated	IP20 Rated

■ **Dimensions & Weight**

Length: 23.54"

Width: 0.5"

Net Weight: 0.3lbs



■ **Application**



T8 LED Quick-Kit 2FT (10W Per Tube)

Ordering Information

Example: T810D30EX1G-FW06

Size	Watts	Dimmable	CCT	One Driver with Tubes	Cap	Lens Type	Length
T8	10W - 10W/Tube	D - 0-10V dimmable	30 - 3000K	EX1 - one driver with one tube	G - G13	FW - Frost White	06 - 2FT
			35 - 3500K	EX2 - one driver with two tubes			
			40 - 4000K	EX3 - one driver with three tubes			
			50 - 5000K	EX4 - one driver with four tubes			

Photometry

All published luminaire photometric testing performed to IESNA LM-79-08 standards by a NVLAP certified laboratory.

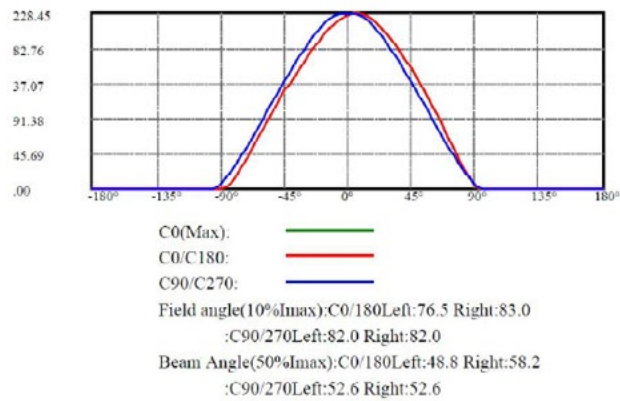
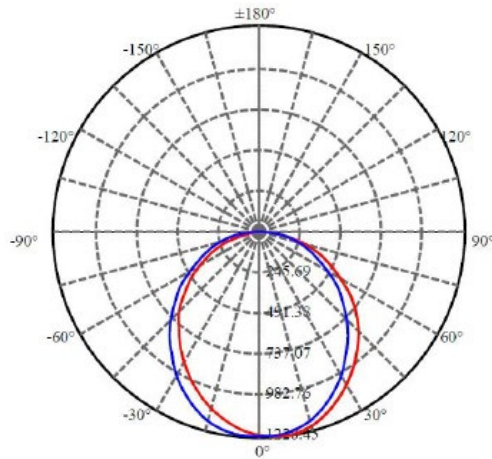

Note: Please visit our website for more details.





■ **FEATURES**

1. External driver, much reliable and convenient.
2. 0-10V dimming can be used with more controls.
3. Rebate-qualified product with high ROI.
4. Title 24 compliance and high efficiency, up to 130LPW.

■ **Performance**

Input Watts	15W (with one tube)	30W (with two tube)	45W (with three tube)	60W (with four tube)
Input Voltage	120-277V	120-277V	120-277V	120-277V
Output Lumens(@5000K)	1950lm	3900lm	5850lm	7800lm
Replaces (FL)	1F32T8(4FT)	2F32T8(4FT)	3F32T8(4FT)	4F32T8(4FT)
Lumen Per Watt	130	130	130	130
Color Accuracy (CRI)	>80	>80	>80	>80
Working Temperature	-4-104°F (-20-40°C)	-4-104°F (-20-40°C)	-4-104°F (-20-40°C)	-4-104°F (-20-40°C)
IP Rating	IP20 Rated	IP20 Rated	IP20 Rated	IP20 Rated

■ **Dimensions & Weight**

Length: 47.17"

Width: 0.5"

Net Weight: 0.57lbs

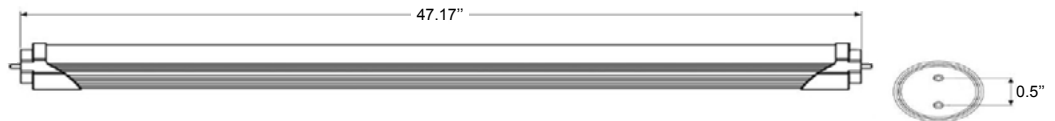

■ **Application**



T8 LED Quick-Kit 4FT (15W Per Tube)

Ordering Information Example: T815D30EX1G-FW12

Size	Watts	Dimmable	CCT	One Driver with Tubes	Cap	Lens Type	Length
T8	15W - 15W/Tube	D - 0-10V dimmable	30 - 3000K	EX1 - one driver with one tube	G - G13	FW - Frost White	12 - 4FT
			35 - 3500K	EX2 - one driver with two tubes			
			40 - 4000K	EX3 - one driver with three tubes			
			50 - 5000K	EX4 - one driver with four tubes			

Photometry

All published luminaire photometric testing performed to IESNA LM-79-08 standards by a NVLAP certified laboratory.

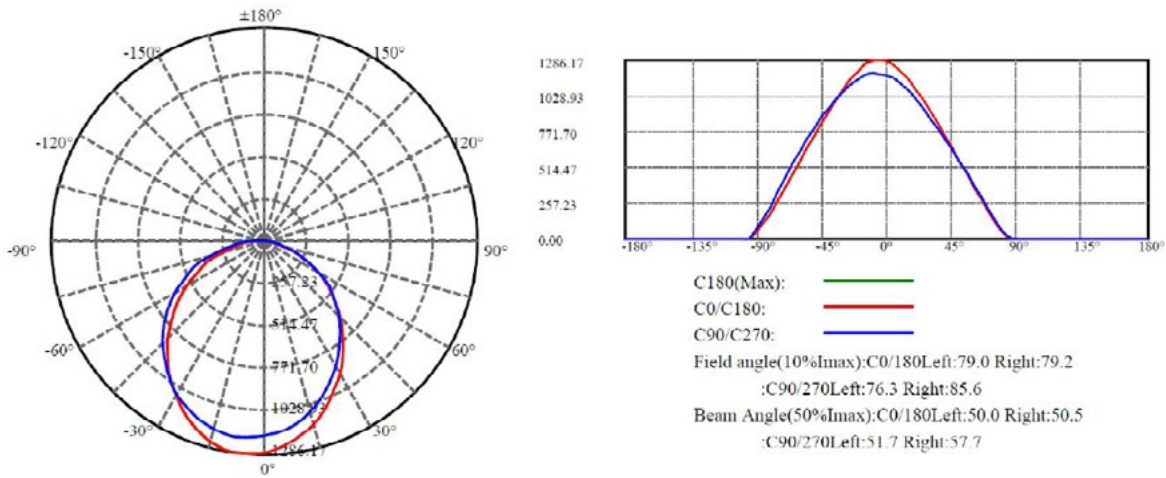

Note: Please visit our website for more details.





■ **FEATURES**

1. External driver, much reliable and convenient.
2. 0-10V dimming can be used with more controls.
3. Rebate-qualified product with high ROI.
4. Title 24 compliance and high efficiency, up to 130LPW.

■ **Performance**

Input Watts	36W (with two tube)	54W (with three tube)	72W (with four tube)
Input Voltage	120-277V	120-277V	120-277V
Output Lumens(@5000K)	4680lm	7020lm	9360lm
Replaces (FL)	2F32T8(4FT)	3F32T8(4FT)	4F32T8(4FT)
Lumen Per Watt	130	130	130
Color Accuracy (CRI)	>80	>80	>80
Working Temperature	-4-104°F (-20-40°C)	-4-104°F (-20-40°C)	-4-104°F (-20-40°C)
IP Rating	IP20 Rated	IP20 Rated	IP20 Rated

■ **Dimensions & Weight**

Length: 47.17"
Width: 0.5"
Net Weight: 0.57lbs

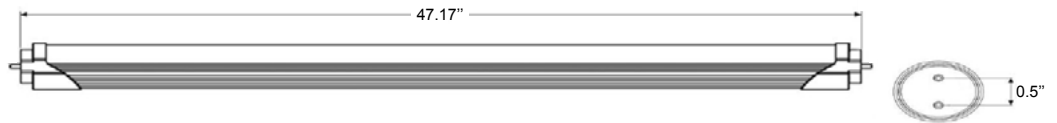

■ **Application**



T8 LED Quick-Kit 4FT (18W Per Tube)

Ordering Information

Example: T818D30EX2G-FW12

Size	Watts	Dimmable	CCT	One Driver with Tubes	Cap	Lens Type	Length
T8	18W - 18W/Tube	D - 0-10V dimmable	30 - 3000K	EX2 - one driver with two tubes	G - G13	FW - Frost White	12 - 4FT
			35 - 3500K	EX3 - one driver with three tubes			
			40 - 4000K	EX4 - one driver with four tubes			
			50 - 5000K				

Photometry

All published luminaire photometric testing performed to IESNA LM-79-08 standards by a NVLAP certified laboratory.

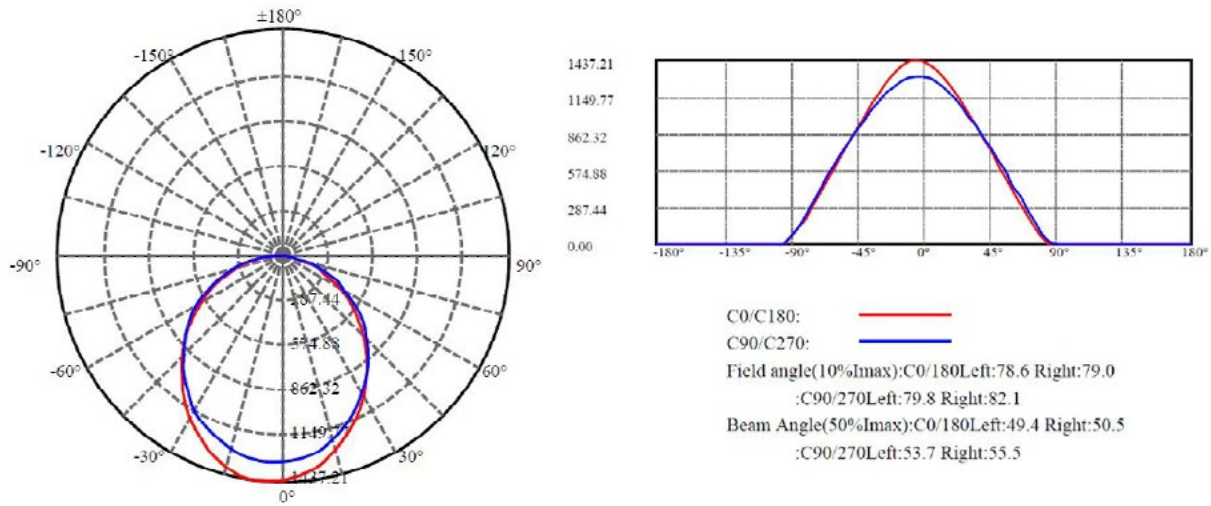

Note: Please visit our website for more details.





■ **FEATURES**

1. High efficacy >140lm/W
2. Compatible most of the FLT8 ballasts in the marketing
3. Full glass housing: No Distortion, No Yellowed, No Embrittled, Great Stability
4. Beam angle >160°
5. Normal quick shipping for 4000K and 5000K
6. R9>20

■ **Performance**

Input Watts	11.5	15
Input Voltage	Compatible with electronic ballast	Compatible with electronic ballast
Output Lumens (@5000K)	1800	2200
Replaces (FL)	32W T8	32W T8
Lumen Per Watt	145	140
Color Accuracy (CRI)	>82	>82
Working Temperature	-4-104°F (-20-40°C)	-4-104°F (-20-40°C)
IP Rating	IP20 Rated	IP20 Rated

■ **Dimensions & Weight**

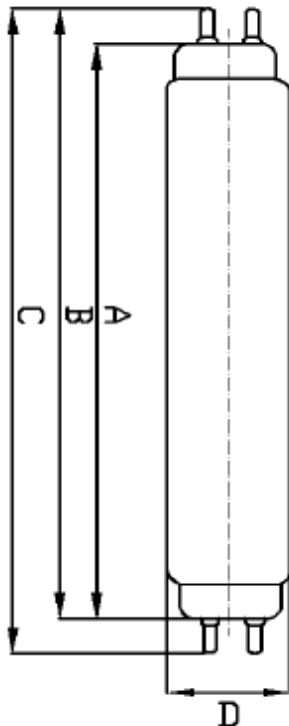

- Max Length A: 47.22"
- Max Length B: 47.50"
- Max Length C: 47.78"
- Max Width D: 1.02"
- Max. Weight: 0.40 lbs

LED Compatible T8 Glass Tube

■ Application

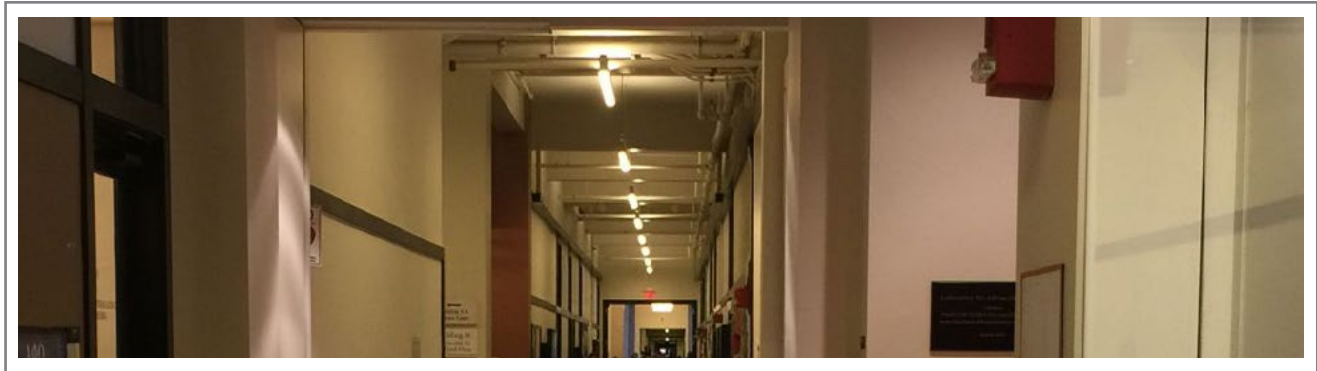

■ Ordering Information Example: T811409-FW12-GL

Size	Watts	CCT	Compatible	Lens Type	Length	Glass Tube
T8	11 - 11.5 Watts	40 - 4000K	9	FW - Frost White ¹	12 - 4FT	GL
	15 - 15 Watts	50 - 5000K				

Notice:

1. Standard Finish as Frost White

* Special Order as other finish color - Please Ask Customer Service for Details.

■ Photometry

All published luminaire photometric testing performed to IESNA LM-79-08 standards by a NVLAP certified laboratory.

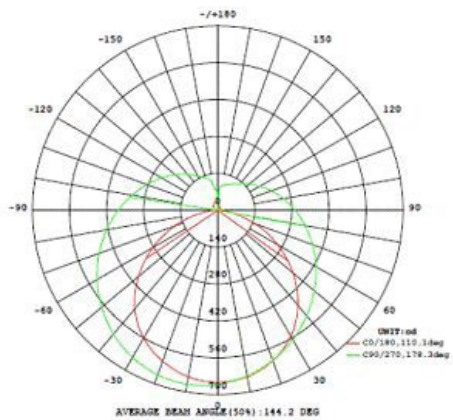

Note: Please visit our website for more details.





■ **FEATURES**

1. High efficacy >140lm/W
2. By pass the ballasts
3. Full glass housing: No Distortion, No Yellowed, No Embrittled, Great Stability
4. Beam angle >160°
5. Normal quick shipping for 4000K and 5000K
6. R9>20

■ **Performance**

Input Watts	11.5	15
Input Voltage	120-277	120-277
Output Lumens (@5000K)	1800	2200
Replaces (FL)	32W T8	32W T8
Lumen Per Watt	145	140
Color Accuracy (CRI)	>82	>82
Working Temperature	-4-104°F (-20-40°C)	-4-104°F (-20-40°C)
IP Rating	IP20 Rated	IP20 Rated

■ **Dimensions & Weight**

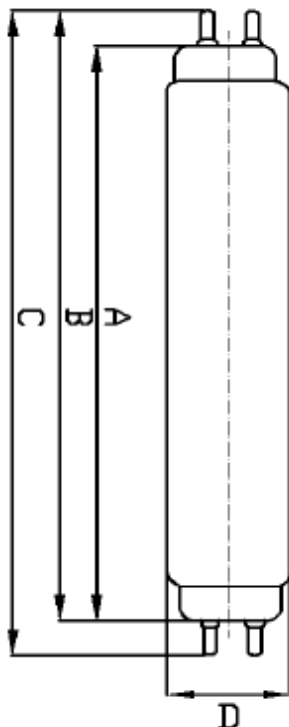

- Max Length A: 47.22"
- Max Length B: 47.50"
- Max Length C: 47.78"
- Max Width D: 1.02"
- Max. Weight: 0.68 lbs

■ Application



■ Ordering Information Example: T811401-FW12-GL

Size	Watts	CCT	AC Direct Wire	Lens Type	Length	Glass Tube
T8	11 - 11.5 Watts	40 - 4000K	1	FW - Frost White ¹	12 - 4FT	GL
	14 - 14.5 Watts	50 - 5000K				

Notice:

1. Standard Finish as Frost White

* Special Order as other finish color - Please Ask Customer Service for Details.

■ Photometry

All published luminaire photometric testing performed to IESNA LM-79-08 standards by a NVLAP certified laboratory.

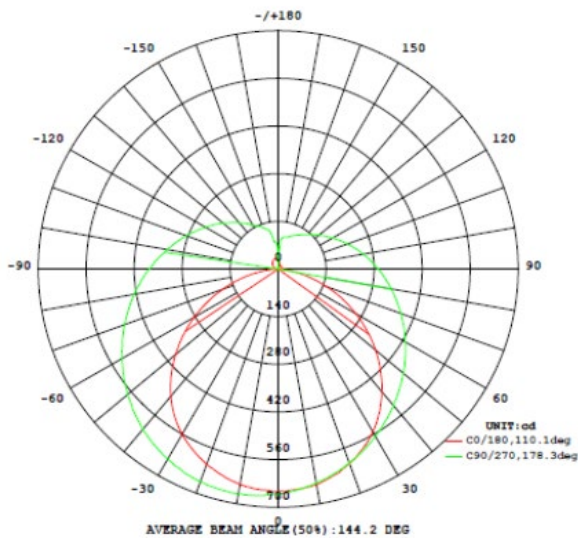

Note: Please visit our website for more details.





■ **FEATURES**

1. High efficacy >140lm/W
2. Compatible most of the HO T5 ballast in the marketing
3. Full glass housing: No Distortion, No Yellowed, No Embrittled, Great Stability
4. Beam angle >160°
5. Normal quick shipping for 4000K and 5000K
6. R9>20

■ **Performance**

Input Watts	25
Input Voltage	Compatible with HO ballast
Output Lumens (@5000K)	3500
Replaces (FL)	54W T5
Lumen Per Watt	140
Color Accuracy (CRI)	>82
Working Temperature	-4-104°F (-20-40°C)
IP Rating	IP20 Rated

■ **Dimensions & Weight**

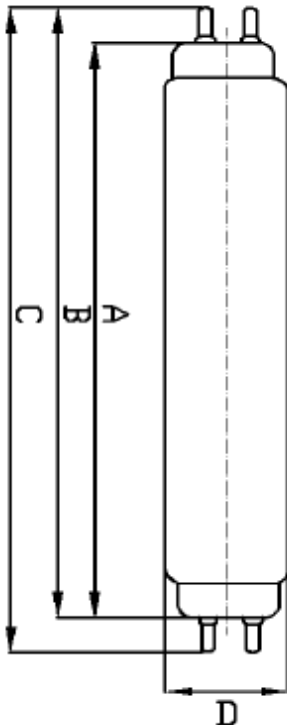

- Max Length A: 45.24"
- Max Length B: 45.52"
- Max Length C: 45.79"
- Max Width D: 0.63"
- Max. Weight: 0.25 lbs

Compatible T5 Tube (Glass)

Application



Ordering Information Example: T525409-FW12-GL

Size	Watts	CCT	Compatible	Lens Type	Length	Glass Tube
T5	25 - 25 Watts	40 - 4000K	9	FW - Frost White ¹	12 - 4FT	GL
		50 - 5000K				

Notice:

1. Standard Finish as Frost White

* Special Order as other finish color - Please Ask Customer Service for Details.

Photometry

All published luminaire photometric testing performed to IESNA LM-79-08 standards by a NVLAP certified laboratory.

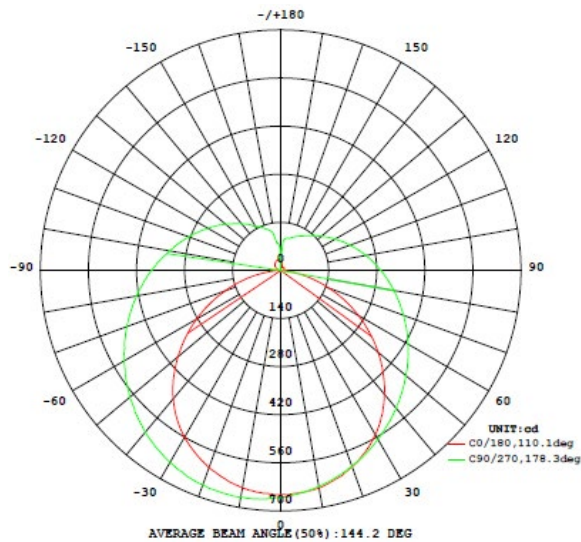

Note: Please visit our website for more details.







**Architecture Design
Outstanding Performance**



ABOVE ALL Lighting, Inc.

 1501 Industrial Way N.
Toms River, NJ 08755

 866-222-8866

 info@abovealllighting.com

 www.AboveAllLighting.com