



**ABOVE ALL**

[www.AboveAllLighting.com](http://www.AboveAllLighting.com)

# THE MOON SERIES

*LED Architectural  
Luminaires*

*Above All Other Lighting*





## STATE OF THE ART AND GRACEFUL DESIGN

The Moon series is specially designed to create comfortable, healthy, and natural light for people.

It can be used in many applications such as sidewalks, factories, schools, gardens, courtyards, parking lots and parks etc.

The idea of main body is from the Moon, elegant and mysterious. To the dark night it brings a glimmer of light and a trace of warmth. It brings the people, light and environment together in harmony. The idea of the whole fixture is from the diamond; shiny and charming.

The low profile design is classic and natural and will look appropriate in any application.



# TECHNICAL SPECIFICATIONS

## LEDs:

High Lumen output, high color rendering index, long-life LEDs. More than 100,000 hours L70 lifespan based on IESNA LM-80 results and IESNA TM-21 calculations in a 77°F ambient.

## LED Driver:

Philips waterproof driver, integral 0-10V dimming with high performance. Power factor is 99%. No electromagnetic interference.

## Lumen Package:

Ranging from 4039 to 16500 lumen for post top application and 4235 to 17500 lumen for LowBay and parking garage and canopy application.

## CCT/CRI:

5000K/70CRI, 4000K/70CRI, 3000K/70CRI.

## IP Rating:

Luminaires are rated IP66.

## Construction & Materials:

Durable and light-weight die-cast ADC12 aluminum housing and extruded aluminum support arms. Cast Aluminum Post Top Tenon Fitter designed to slip over a standard 2 3/8" and 3" tenon. Ease of installation.

## Color Finish:

Fixture are chemically pretreated through 8 stages and finished with thermoset and corrosion resistant polyester powder coat. 3 to 5 mils nominal thickness. Finish is oven-baked at 400°F to 570°F for 30 to 45 minutes. It can withstand extreme weather changes without cracking or peeling. Available in standard dark bronze color and aluminum silver color and custom colors.

## Suggested Replacement

35W to replace 100-150W HID/100W HPS  
50W to replace 150-175W HID/ 100-150W HPS  
75W to replace 175-250W HID/ 200W HPS  
100W to replace 250-400W HID/ 250W HPS  
135W to replace 400W HID

## Warranty:

12 years limited warranty

## Listings:

- cETLus conforms to UL Std. 1598 Cert. to CSA Std. C22.2 No.250.0
- IP66 rated
- DLC qualified
- RoHS compliant



# LOW BAY AND PARKING GARAGE FIXTURE FEATURE

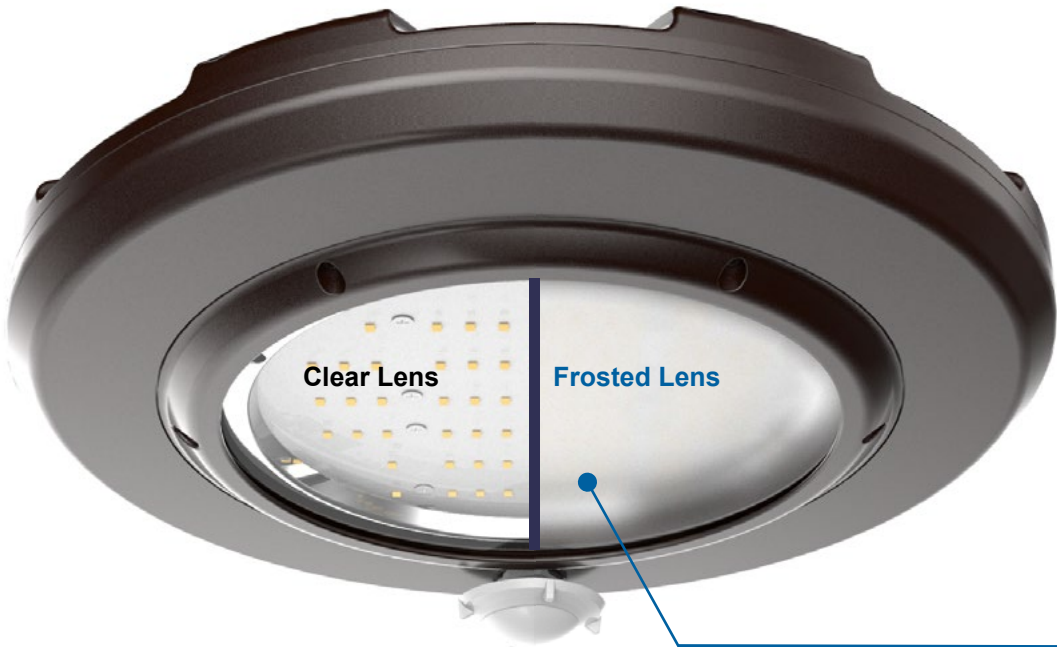

Low Glare Design

Hook Mount



Pendant Mount



Surface Mount



# CONSTRUCTION FEATURES

**Top:**  
Die-casting aluminum.

**LED Driver:**  
Philips waterproof driver, integral 0-10V dimming.

**Gasket:**  
Extruded silicone gasket for complete weatherproof sealing.

**Heat Sink:**  
Air-flow fins for superior heat dissipation.

**Reflector:**  
Buyer aluminum plated polycarbonate.

**Lens:**  
Clear tempered glass lens.

**Support Arms:**  
Extruded aluminum.

**Post Top Tenon Fitter:**  
Die-casting aluminum tenon fitter designed to slip over a standard 2 3/8" and 3" tenon

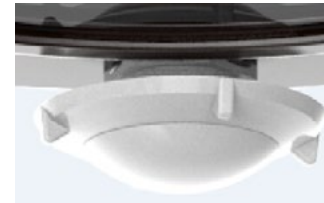
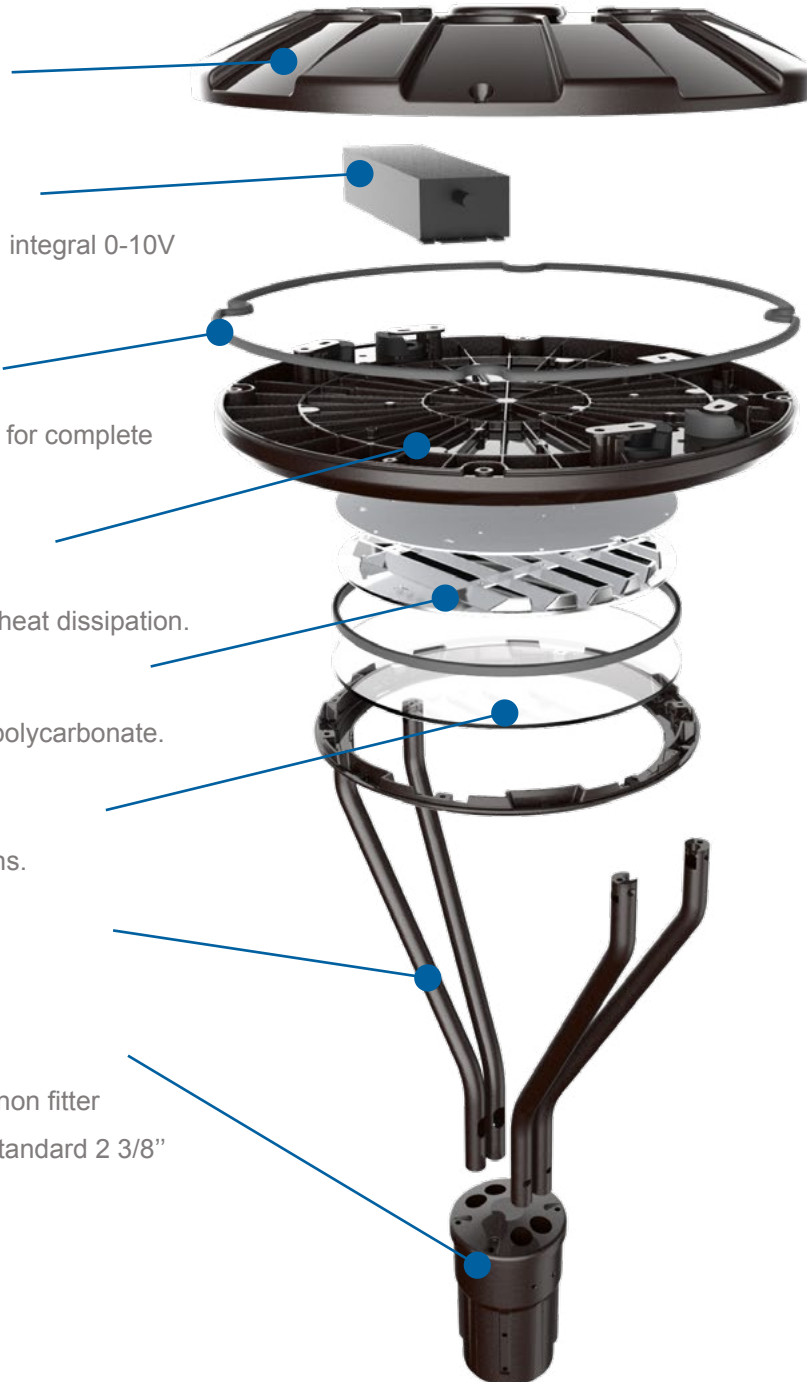

**Optional Motion Sensor:**  
Used in conjunction with Dimming Controls. Energy Savings.



**Optional Controls:**  
NEMA 3-PIN / 7-PIN photocontrol receptacle. Energy Savings.



**Surge protection Device:**  
Integral Philips 10KA surge suppression protection as standard. Guaranteeing a longer projected life.



**LED and Reflector:**  
High performance Samsung and LG LED chip. Premium optical systems featuring 95% reflectivity.



**The Real Solution For  
Versatile Urban Lighting**

# ORDERING INFORMATION

## Example: MPT35501-MS-L3B-P1-V

Moon Series	Watts	CCT	Voltage	Control	Installation	Distribution	Lens	Finish
MPT	35 - 35W	30 - 3000K	1 - 120-277V	MS - L3B - Wattstopper	P1 - 2 3/8" or 3"	V - Type V	Blank - Glass	Blank - Dark Bronze
	50 - 50W	40 - 4000K	2 - 347V <sup>1</sup>	Sensor	Tenon pole <sup>6</sup>	III - Type III	Clear Lens <sup>7</sup>	AL - Aluminum Silver
	75 - 75W	50 - 5000K	3 - 480V <sup>2</sup>	With Black L3 Lens <sup>4</sup>		II - Type II	GFL- Glass	
	100 - 100W		6 - 347/480V <sup>3</sup>	MS - L7B - Wattstopper			Frosted Lens	
	135 - 135W			Sensor with Black L7 Lens <sup>4</sup>			PCL-Polycarbonate	
				PC - Photoelectric Control			Clear Lens <sup>8</sup>	
				7P - 7-Pin PE Receptacle <sup>5</sup>			PDL-Polycarbonate	
							Diffused Lens <sup>8</sup>	

### Notes:

- Single voltage 347V is only used with photoelectric control.
  - Single voltage 480V is only used with photoelectric control.
  - 347/480 is available for 75W/100W/135W. If for 35W and 50W, it is 120-347V. Besides, 347/480V is not available for photoelectric control.
  - Wattstopper sensor is not available for 347/480V. Black L3 lens is standard for 35W and 50W; Black L7 lens is standard for 75W, 100W and 135W. Please check the motion sensor manual for more information.
  - Shorting cap included.
  - 4" OD round and square pole adapter is available for accessory.
  - Glass clear lens is standard. GFL, PCL and PDL may take long time- Please Ask Customer Service for Details.
  - Polycarbonate lens is IK10 rated.
- \* Standard Finish is Dark Bronze. Special Order as other finish color will take long time - Please Ask Customer Service for Details.

## Accessories



**90178**  
MPT-4RPA  
4"OD round pole adapter



**90534**  
MPT-4SPA  
4" Square Pole Adapter



**90594**  
PT-WMB  
Wall mount bracket for post top



**90198**  
MPT-HSS  
House side shield for MPT/MLB

## Example: MLB75501-MS-L7B

Name	Watts	CCT	Voltage	Control	Distribution	Lens	Finish
MLB	35 - 35W	30 - 3000K	1 - 120-277V	Blank - None	Blank - Type V	Blank - Glass Clear Lens <sup>3</sup>	Blank - Dark Bronze
	50 - 50W	40 - 4000K	6 - 347/480V	MS - L7B-Wattstopper	II - Type II	GFL- Glass Frosted Lens	AL - Aluminum Silver
	75 - 75W	50 - 5000K		Sensor with Black L7	III - Type III	PCL-Polycarbonate Clear Lens <sup>5</sup>	
	100 - 100W			Lens <sup>2</sup>		PDL-Polycarbonate Diffused Lens <sup>5</sup>	
	135 - 135W			MOD - Enlighted Sensor <sup>4</sup>			

### Notes:

- 347/480 is available for 75W/100W/135W. If for 35W and 50W, it is 120-347V. No controls for 347/480V
- Motion sensor is not available for 347/480V. Black L7 lens is standard.
- Glass clear lens is standard. GFL, PCL and PDL will take long time - Please Ask Customer Service for Details.
- Enlighted sensor will take long time. "Gateway program" need to be purchased separately- Please Ask Customer Service in advance for Details
- Polycarbonate lens is IK10 rated.

\* Dark bronze is standard. Custom color is available for a premium setup fee. Consult customer service for additional information.

## Accessories (Ordered separately & field installed)



**90198**  
MPT-HSS  
House side shield for Moon series

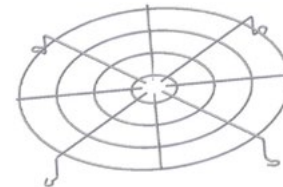

**90481**  
MLB-WG  
Wire guard for Moon series



**90194**  
MLB-HM  
Hook for moon series low bay, garage and canopy



**90097**  
6 feet white 120V Plug and Cord



**90098**  
6 feet white 277V Plug and Cord



6 feet black three-wire cable, 600V

### Notes:

- If without hook accessory, it is suitable for pendant mount and surface mount.



# PERFORMANCE

## Post Top

Input Watts: 35W /47.8W /72.1W /99.4W/ 135W

Input Voltage: 120-277V

Output Lumens (@3000k/ 5000K):

4039lm /5319lm/8057.4lm/11595lm/16500lm

Replaces (MH): 150W/175W/250W/320W/400W

Lumen Per Watt: 115/111/111.8/116.7/124

Color Accuracy (CRI): >70

Working Temperature: -40-104 °F (-40-40 °C)

## Low Bay and Parking Garage Fixture With Clear Glass Lens

Input Watts: 35W/50W/75W/100W/ 135W

Input Voltage: 120-277V

Output Lumens (@5000K):

4770lm/6700lm/10200lm/13500lm/ 17500lm

Replaces (MH): 150W/175W/250W/320W/ 400W

Lumen Per Watt: 136/134/136/135/ 130

Color Accuracy (CRI): >70

Working Temperature: -40-104 °F (-40-40 °C)

## Low Bay and Parking Garage Fixture With Frosted Glass Lens

Input Watts: 35W/50W/75W/100W/ 135W

Input Voltage: 120-277V

Output Lumens (@5000K):

4235lm/5950lm/9075lm/12000lm/ 15660lm

Replaces (MH): 150W/175W/250W/320W/400W

Lumen Per Watt: 121/119/121/120/116

Color Accuracy (CRI): >70

Working Temperature: -40-104 °F (-40-40 °C)

# DIMENSIONS

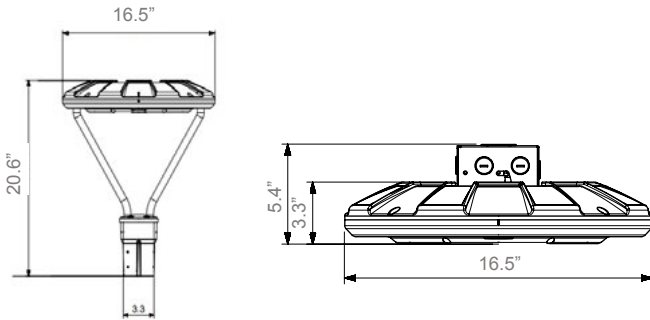

### Spider Post Top Mount

For standard 2 3/8" and 3" tenon or pole.

### Pendant Mount

3/4" pendant mounting adapter for High/Low Bay and Parking Garage Light

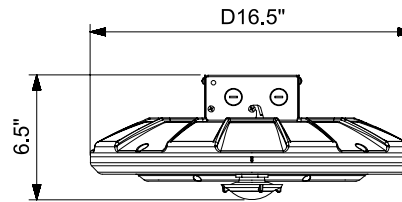

### Pendant Mount with Sensor

Diameter: 16.5"

Height: 6.5"

Max. Weight: 15.9 lbs

The Cable Wire Length: 11.8"

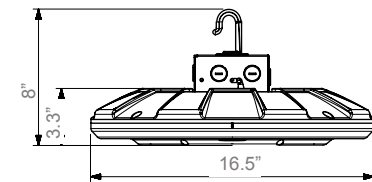

### Hook Mount

Especially for High/Low Bay Light





[www.AboveAllLighting.com](http://www.AboveAllLighting.com)

**ABOVE ALL Lighting, Inc.**

 1501 Industrial Way N.  
Toms River, NJ 08755

 866-222-8866

 [info@abovealllighting.com](mailto:info@abovealllighting.com)

 [www.AboveAllLighting.com](http://www.AboveAllLighting.com)

©2017 ABOVE ALL all rights reserved

