

MAGNETIC TRACK PROFILE

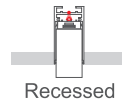
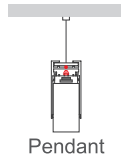
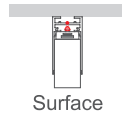

PRODUCT DESCRIPTION

The ultimate in modern aesthetics. It isn't just about track rail, it's also about creating unique lighting configurations. Thanks to different types of corners, the geometrical possibilities really are endless. Light components, ranging from linear, wall washer to adjustable spotlights and decorative pendants snap in the track magnetically, without tools. Standard length is available in 1, 2 & 3 meter sections and can be surface, recessed or pendant mounted.

GENERAL SPECIFICATION

Material	Aluminum
Color	RAL9004 Black/RAL 9003 White
Input Voltage	24Vdc
Input Current	8A Max

DIMENSION

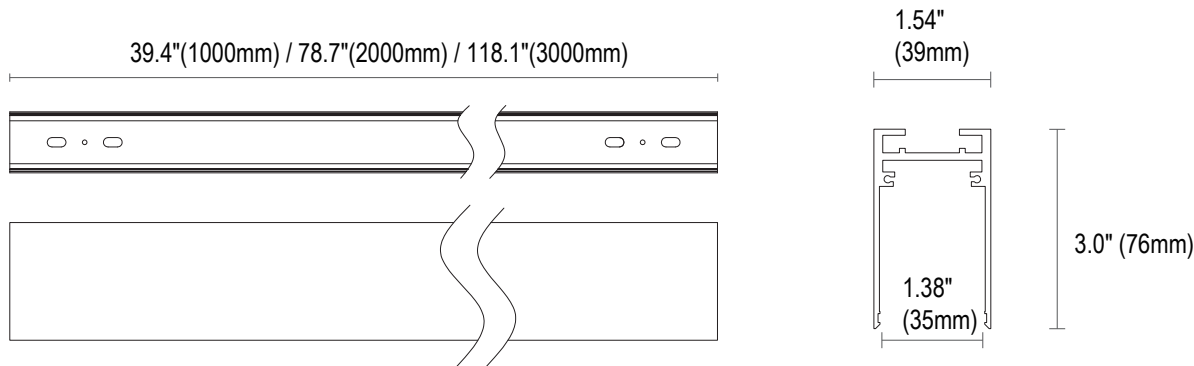

Ordering Information

Example: MTS1M-24V-BK

Series	Length	- Voltage	Installation	- Frame Finish
MTS -Magnetic Track Profile	1M -39"	- 24V-24Vdc ¹	Need to order and ship separately ²	- BK -Black ³
	2M -79"			Optional
	3M -118"			WH -White ³
			PMK -Pendant Mount Kits	
			SMK- Surface Mount Kits	
			RMK- Recessed Mount Kits	

Notice:

1. The Input terminal need to be bought separately. 24V constant voltage LED drivers can be chosen in the following driver list or supplied by customer.
2. Different mounting kits need to be bought separately. Please check the details in the following accessory list.
3. Black finish is standard. Custom color is available for a premium setup fee. Consult customer service for additional information.

ACCESSORIES (ORDER AND SHIP SEPARATELY)

POWER FEED

Input terminal

■ Sandy Black □ Sandy White

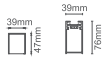

MTS-IT-BK

Input terminal for magnetic track, includes pin connector, track connector and cable

* 24V constant voltage LED drivers can be chosen in the following driver list. The 24V constant voltage LED drivers also can be supplied by customer. The total fixture wattages can't exceed 200W.

CORNER

L Corner

■ Sandy Black □ Sandy White

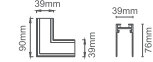

MTS-LC-BK

Inner Corner

■ Sandy Black □ Sandy White

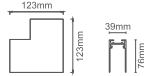
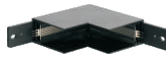

MTS-IC-BK

Outer Corner

■ Sandy Black □ Sandy White

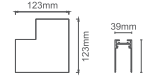

MTS-OC-BK

T corner

■ Sandy Black □ Sandy White

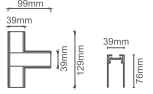

MTS-TC-BK

45D corner

■ Sandy Black □ Sandy White

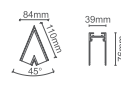

MTS-VC-BK

CROSS corner

■ Sandy Black □ Sandy White

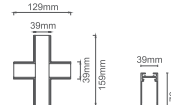

MTS-CC-BK

MOUNTING

Recessed kit

■ Sandy Black □ Sandy White



Recess mounting kit for magnetic track.

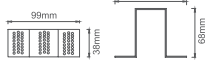

MTS-RM-BK

* 2 pieces per set.

Pendant kit-A

■ Sandy Black □ Sandy White



Suspension 1.2meters with electrical wire (1 pc).

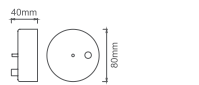

MTS-PM-A-BK

Pendant kit-B

■ Sandy Black □ Sandy White



Suspension 1.2meters(1pc).

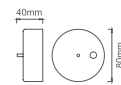

MTS-PM-B-BK

Track connector

■ Sandy Black □ Sandy White



MTS-CNCT-BK

* The track connector must be worked together with power plate

Power plate 65mm

■ Sandy Black □ Sandy White

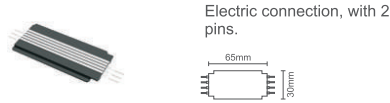

MTS-PP-65-BK

New surface mounted kits

■ Sandy Black □ Sandy White



MTS-SM-BK

New surface mounted for magnetic track, includes 4pcs

Track cover

■ Sandy Black □ Sandy White

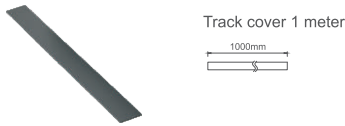

MTS-COVER-BK

Driver box

■ Sandy Black □ Sandy White

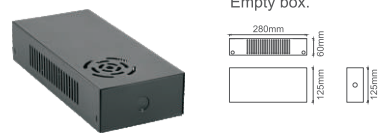

MTS-DBOX-BK

End cap

■ Sandy Black □ Sandy White

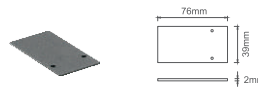

MTS-CAP-BK

Track bridge

■ Sandy Black □ Sandy White



MTS-TB-BK

Pin3

□ Sandy White

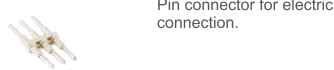

MTS-PIN3

CONSTANT VOLTAGE LED DRIVER LIST
(ORDER AND SHIP SEPARATELY)

NON-DIMMABLE LED DRIVER

50W



XLG-50-24

50W, non-dimmable
Size: 180x63x35.5mm
input voltage: AC100-305V,
output voltage: 24V DC

100W



XLG-100-24

100W, non-dimmable
Size: 180x63x35.5mm
input voltage: AC100-305V,
output voltage: 24V DC

150W



XLG-150-24

150W, non-dimmable
Size: 180x63x35.5mm
input voltage: AC100-305V,
output voltage: 24V DC

200W



XLG-200-24

200W, non-dimmable
Size: 180x63x35.5mm
input voltage: AC100-305V,
output voltage: 24V DC

5 IN 1 DIMMABLE LED DRIVER

80W

KVG-24080-DWJ

80W, Triac/0-10V/1-10V/10V PWM
 Size: 220x93x41mm
 input voltage: 120-277V
 output voltage: 24V DC

100W

KVG-24100-DWJ

100W, Triac/0-10V/1-10V/10V PWM
 Size: 220x93x41mm
 input voltage: 120-277V
 output voltage: 24V DC

150W

KVG-24150-DWJ

150W, Triac/0-10V/1-10V/10V PWM
 Size: 260x103x46mm
 input voltage: 120-277V
 output voltage: 24V DC

200W

KVG-24200-DWJ

200W, Triac/0-10V/1-10V/10V PWM
 Size: 260x103x46mm
 input voltage: 120-277V
 output voltage: 24V DC

DALI INTELLIGENT LED DRIVER

100W

LM-100-24-G1D2

100W, DALI-2, Push DIM
 Size: 352x43x30mm(LxWxH)
 input voltage: AC120-277V,
 output voltage: 24V DC

Warranty

Five year limited warranty.

Working temperature: -20°C to + 40°C(-4 °F to 104°F)

Specifications subject to change without notice.