

3.8" WIDE MAGIC LED LINEAR LIGHT Suspended Mount



PRODUCT DESCRIPTION

This MAGIC led linear fixture is a 3.8" wide linear architectural luminaire with a slim and discreet profile. The MAGIC is available in standard lengths of 2', 3', 4', and 8', and can be joined together in seamless runs of desired length. The MAGIC is an affordable indirect/direct linear LED luminaire. Various optical design delivers uniform, continuous lines of light. Different pattern joiners available for unlimited lighting pattern design.

FEATURES

- Comes in lengths of 2', 3', 4' and 8'
- 7 Direct/Indirect lighting distributing options
- Available with several lit joiner accessories for unlimited lighting pattern design
- Flat lens and deep regressed lens options
- CCT & wattage adjustable, up to 1200lm/ft
- Microwave sensor and EBU are available

ELECTRICAL SYSTEM

- Input Voltage: 120-277V, 50/60Hz
- Operating temperature range: -4-104°F (-20-40°C)
- Power Factor: > 0.9 at full load
- Total Harmonic Distortion: < 20% at full load

SPECIFICATION

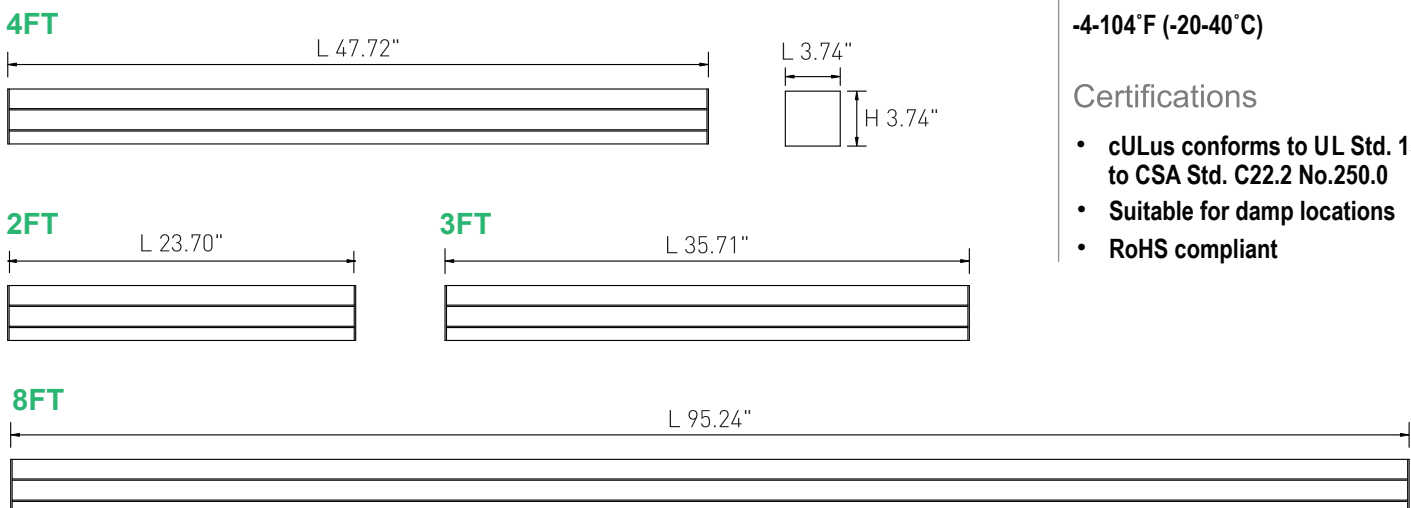

PERFORMANCE

CRI

80

CCT

3000K, 3500K, 4000K

Dimming

- Dim to 10% (standard)
- Dim to 1% (optional)

Compatible Dimmer

- LUTRON: DVSTV
- LEVITON: IP710

Projected Lifetime

L70 - 100,000 Hours

Working Temperature

-4-104°F (-20-40°C)

Certifications

- cULus conforms to UL Std. 1598Cert. to CSA Std. C22.2 No.250.0
- Suitable for damp locations
- RoHS compliant

Ordering Information

Example: MAG1238-SW1-10D-PM-SD-FDL

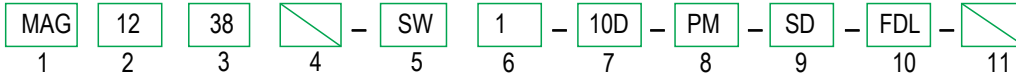

1. Series

MAG

2. Length

06 - 2FT 09 - 3FT 12 - 4FT 24 - 8FT

Option - Desired System Length*

* Individual fixtures, Runs and Configurations are supplied in nominal lengths to ensure full, even, illumination. If desired runs and configurations are needed, please tell us the details in advance. Then we can prepare the middle run and end run in factory for easy installation, or end user need to modify the standard individual fixtures into middle run and end run.

3. Width

38- 3.8 Inch

4. Driver

Blank - Integral

5. CCT

SW- 3000K/3500K/4000K Selectable

1. Default setting is 3500K.

6. Voltage

1 - 120-277V

7. Dimming

10D - 0-10V, dim to 10%
(Standard)

01D - 0-10V, dim to 1%
(Optional)

8. Mounting Options

PM - Suspended Mount

1. Please refer to the following accessory table to choose the right mounting kits.

9. Light Distribution

SD -Following options available by dip switch

100% Uplight

10% down, 90% up

30% down, 70% up

50% down, 50% up

70% down, 30% up

90% down, 10% up

100% Downlight

1. Default setting is 100% downlight.

10. Lens Options

FDL - Flush Diffused Lens RGL - Regressed

* If the joined length exceeds 8ft, only continuous Roll-Out Lens can be used.

11. Finish

Blank - White

BK - Black

Accessories (ordered separately and field installed)

Drop Ceiling Suspension Mount List



MAG-PMK3-5FT

Aircraft Cable Pendant Mount Kits for Drop Ceiling, with 5ft aircraft cable and 5ft power cord (One set per fixture)



MAG-PMK3-12FT

Aircraft Cable Pendant Mount Kits for Drop Ceiling, with 12ft aircraft cable and 12ft power cord (One set per fixture)

* Suitable for 9/16" and 15/16" Flat Ceiling.
 If for 9/16" slot ceiling please contact Customer Service.

Dry Ceiling Suspension Mount List



MAG-PMK1-5FT

Aircraft Cable Pendant Mount Kits for Dry Ceiling, with 5ft aircraft cable and 5ft power cord (One set per fixture)

MAG-PMK1-12FT

Aircraft Cable Pendant Mount Kits for Dry Ceiling, with 12ft aircraft cable and 12ft power cord (One set per fixture)



EBU-H08170²

8W Emergency Battery Back-up for for MAX.60W fixture



MAG-MSW-PM/SM

Microwave Motion Sensor Kits for pendant mount

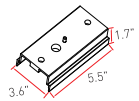

MAG38-LINE

Illuminated Line Shaped Joiner

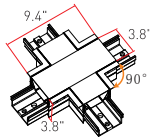

MAG38-CROSS

Illuminated Cross Shaped Joiner

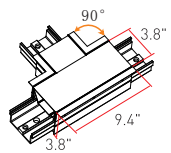

MAG38-T

Illuminated T Shaped Joiner

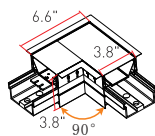

MAG38-L

Illuminated 90° L Shaped Joiner

EBU-H25170²

25W Emergency Battery Back-up for for MAX.200W fixture

* Emergency battery back-up is for ambient temperatures of 32°F -95°F (0 °C -35°C).



AAL-RC-100

Remote Control for Microwave Motion Sensor



MAG38-ROL¹

Continuous Roll-Out Lens (42')

* If the joined length exceeds 8ft, only continuous Roll-Out Lens can be used.

PERFORMANCE DATA

Lumen values are measured by third party certified laboratories performed in accordance with IESNA LM-79-08 as well as Lighting Facts listed.

Optics	Length	UP/DOWN @3500K (Base on 50%Up/50%Down)			100%DOWN@3500K		
		High	Medium	Low	High	Medium	Low
Flat Lens	2',3',4',8'	1200lm/ft, 10w/ft	900lm/ft, 7.5w/ft	600lm/ft, 5w/ft	1100lm/ft, 10w/ft	800lm/ft, 7.5w/ft	550lm/ft, 5w/ft
Regressed Lens	2',3',4',8'	1000lm/ft, 10w/ft	750lm/ft, 7.5w/ft	500lm/ft, 5w/ft	900lm/ft, 10w/ft	670lm/ft, 7.5w/ft	450lm/ft, 5w/ft

Notes: Above are subject to 3500. All efficacy is $\pm 5\%$ base on different CCT and lighting distributions. Check the IES file to gain the accurate data .For 3000K fixtures, use 0.96 multiplier; For 4000K fixtures, use 1.04 multiplier.

PHOTOMETRY

All published luminaire photo metric testing performed to IESNA LM-79-08 standards by a NVLAP certified laboratory. IESNA LM-79-08 specifies the entire luminaire as the source resulting in a fixture efficiency of 100%.Result may vary per actual order.

2' / Flat Lens / 35000K/
Up 50%,Down 50%

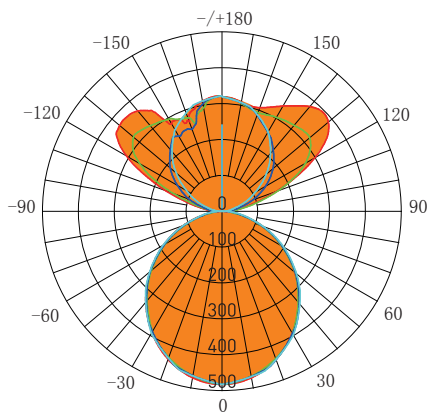

AVERAGE BEAM ANGLE(50%): 360.0°

Lumens: 2397.2 Lms
Watts: 20.20 W
LPW: 118.66 Lm/W
CCT: 3500K

UNIT:cd
 — C0/180,360°
 — C30/210,360°
 — C60/240,360°
 — C90/270,360°

4' / Flat Lens / 35000K/
Up 50%,Down 50%

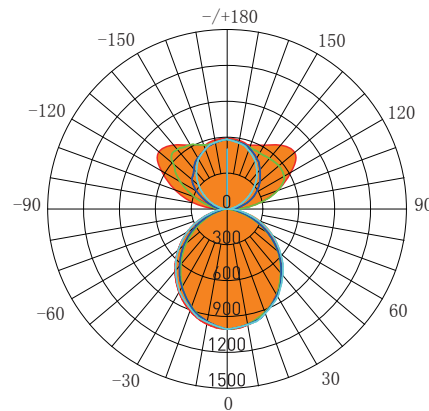

AVERAGE BEAM ANGLE(50%): 360.0°

Lumens: 4849.1 Lms
Watts: 38.09 W
LPW: 127.32 Lm/W
CCT: 3500K

UNIT:cd
 — C0/180,360°
 — C30/210,360°
 — C60/240,360°
 — C90/270,1360°

MICROWAVE DIMMING SENSOR SETTING (120-277V)

By selecting the combination on the DIP switch, sensor data can be precisely set for each specific application. The sensor setting also can be done by a remote control (RC-100) which need to be bought separately.

	1	2	
I	↓	↓	20%
II	↓	↑	50%
III	↑	↓	75%
IV	↑	↑	100%

Sensitivity

Sensitivity can be reduced by selecting the combination on the DIP switches to fit precisely each application .

Default Setting: 100%

	3	4	
I	↓	↓	10 S
II	↓	↑	1 Min
III	↑	↓	5 Min
IV	↑	↑	15 Min

Hold time

Refers to the time period the lamp remains at 100% illumination after no motion detected.

Default Setting: 15min

	5	6	
I	↓	↓	
II	↓	↑	10 Lux
III	↑	↓	30 Lux
IV	↑	↑	50 Lux

Daylight sensor

The sensor can be set to only allow the lamp to illuminate below a defined ambient brightness threshold.

Default Setting:  (Disable)

	7	8	
I	↓	↓	0%
II	↓	↑	10%
III	↑	↓	30%
IV	↑	↑	50%

Stand-by dimming level

The low light level you would like to have after the hold time in the long absence of people.

Default Setting: 50%

	9	10	
I	↓	↓	+ ∞
II	↓	↑	1 Min
III	↑	↓	30 Min
IV	↑	↑	60 Min

Stand-by time

Refers to the time period the lamp remains at a low light level before it completely switches off in the long absence of people. When set to “ +∞ ” mode, the low light is maintained until motion is detected

Default Setting: 30 Min

Warranty

Five year limited warranty.

Note:

Specifications subject to change without notice.