

**⚠ RISK OF FIRE AND ELECTRICAL SHOCK. FIXTURE MUST BE INSTALLED BY A QUALIFIED ELECTRICIAN ONLY IN ACCORDANCE WITH NATIONAL, LOCAL BUILDING AND ELECTRICAL CODES. DISCONNECT POWER AT ELECTRICAL PANEL BEFORE SERVICING.**

## Drywall

### Recessed bracket

Top View

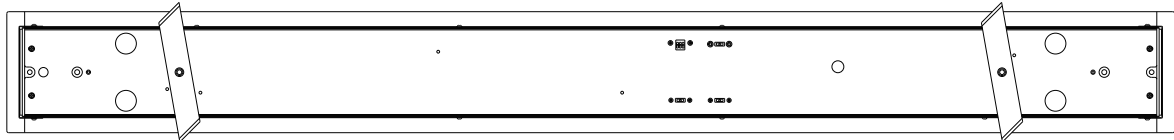

Side View

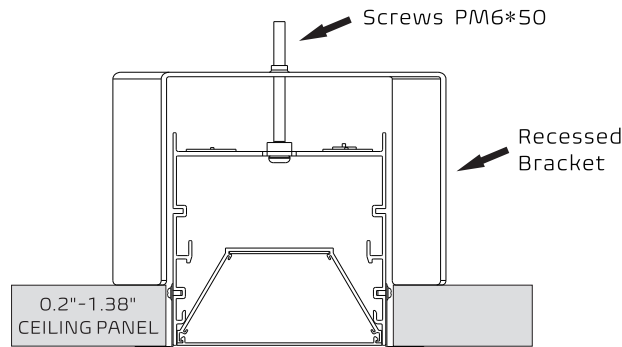
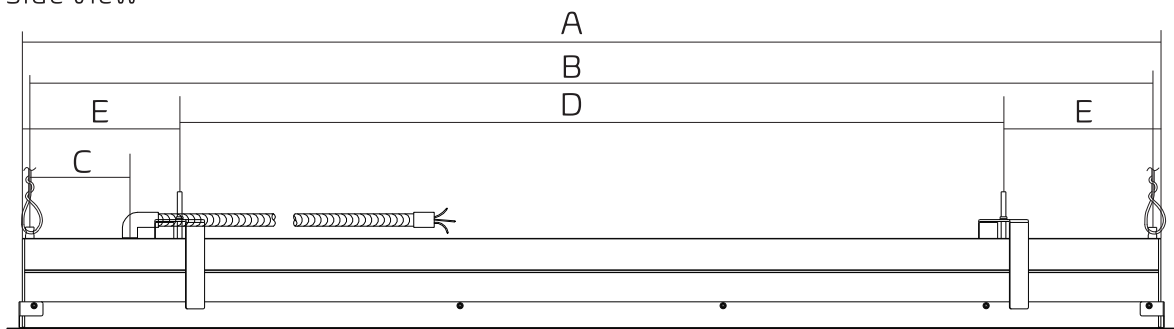

DRY CEILING AND GRID CEILING - DIMENSIONS						
Nominal Length	"A" Housing Length	"B" Wire Rope	"C" Feed Location		"D" Rod Spacing	"E" End Suspensions
	Feet	Feet	2.3" Width Linear	3.8" Width Linear	Feet	Feet
2 ft.	1.98'	1.92'	3.58"	4.33"	0.88'	0.54'
3 ft.	2.98'	2.94'	3.58"	4.33"	1.88'	0.54'
4 ft.	3.98'	3.94'	3.58"	4.33"	2.88'	0.54'
8 ft.	7.96'	7.90'	3.58"	4.33"	6.84'	0.54'

**⚠ RISK OF FIRE AND ELECTRICAL SHOCK. FIXTURE MUST BE INSTALLED BY A QUALIFIED ELECTRICIAN ONLY IN ACCORDANCE WITH NATIONAL, LOCAL BUILDING AND ELECTRICAL CODES. DISCONNECT POWER AT ELECTRICAL PANEL BEFORE SERVICING.**

**IMPORTANT**

1. Read all instructions.
2. Install in accordance with national and local electrical code regulations.
3. This product is intended to be installed and serviced by a qualified, licensed electrician.
4. Do not install in wet locations. For dry and damp use only.
5. Turn off electrical power before installing or servicing fixture in any way.
6. To reduce the risk of fire and overheating, make sure all connections are tight.
7. Under no circumstances can the lighting fixture be covered with heat insulation gasket or similar materials.
8. The maximum connection of each input line is 40FT in 120AC, 100FT in 277AC.

**SHOCK HAZARD**

**⚡** May result in serious injury or death. Turn power OFF at circuit breaker prior to installation or servicing.

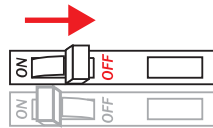



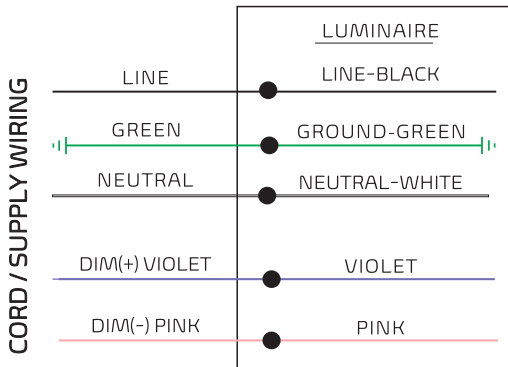



**WIRING**

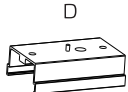
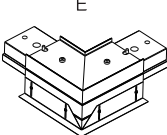

**⚠** Please isolate two dimming wires by P2 terminal individually if no need dimming; Must connect wires with corresponding colors as shown.

**PARTS LISTS**

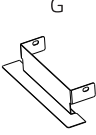
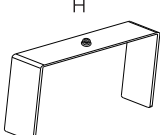
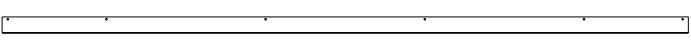
**MUD-IN DRYWALL**

 <b>A</b> <b>Screws</b> Screws to fix the drywall flange kit to housing	 <b>B</b> <b>PC Diffuser</b> Optional continuous rolling lens which can reach seamless continue runs up to 42' is available.	 <b>C</b> <b>Silicone Seal</b> Note: Silicone seal is used to seal seams that may appear at both ends of luminaires when multiple connections.	 <b>D</b> <b>"L" Joinder</b>
 <b>E</b> <b>"L" Joinder</b>	 <b>F</b> <b>Safety Stud</b>	 <b>G</b> <b>Trim Drywall End Cap</b>	 <b>H</b> <b>Recessed Bracket</b>
 <b>I</b> <b>Trim Drywall Flange Kit</b>			
 <b>J</b> <b>Screws</b> Screws for Recessed bracket			

**⚠ RISK OF FIRE AND ELECTRICAL SHOCK. FIXTURE MUST BE INSTALLED BY A QUALIFIED ELECTRICIAN ONLY IN ACCORDANCE WITH NATIONAL, LOCAL BUILDING AND ELECTRICAL CODES. DISCONNECT POWER AT ELECTRICAL PANEL BEFORE SERVICING.**

**BEFORE CONNECTING**

**INDEPENDENT INSTALLATION**

① Install end caps as shown

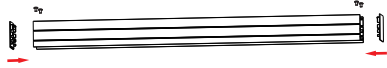

③ Fix the end cap (G) of Trim Drywall to both ends of the fixture with screws (A), and screw the lifting stud (F) onto both ends of the top of the fixture.

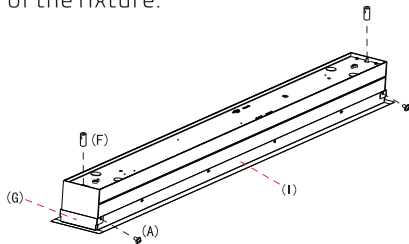

② Install Trim Drywall (I) at both ends of fixture using screw (A) (Only fix the middle hole, Unfixed head and tail hole)

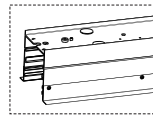

Flange kit bracket need align with luminaire 2 ends

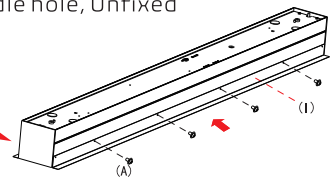

④ Secure the LED modules with aircraft cable and connect the DC male and female terminals.

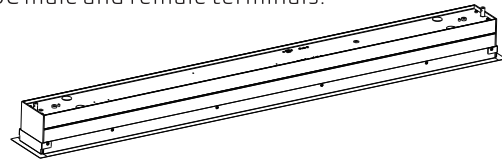

**MULTIPLE LUMINAIRES CONNECTION – LINE CONNECTION**

① Install end caps and line joiners

START OF RUN  
Install end caps and Line joiners as shown

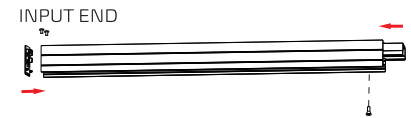

MIDDLE OF RUN  
Install Line joiners as shown

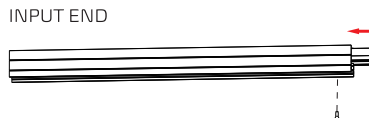

END OF RUN  
Install end caps as shown

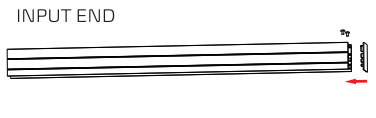

② Install two side trim drywall (I), one side end cap (G) & Safety stud (F)

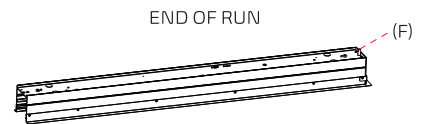
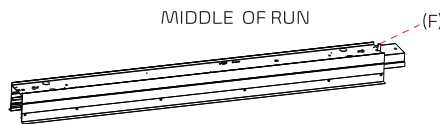
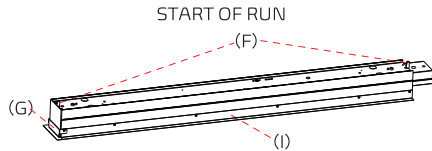

③ Secure the LED modules with aircraft cable and connect the DC male and female terminals

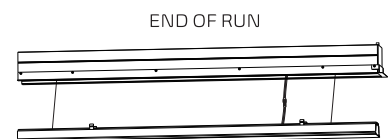
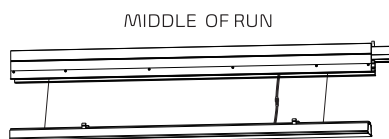
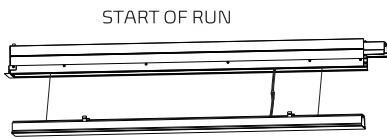

**MULTIPLE LUMINAIRES CONNECTION – L SHAPE CONNECTION**

① Install the end caps

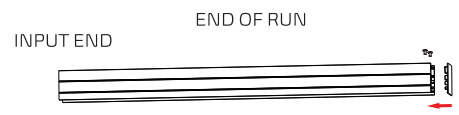
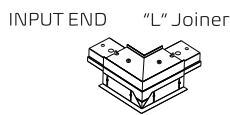
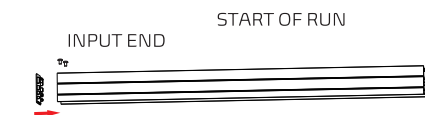

② Install two side trim drywall (J), one side end cap (I) & Safety stud (H)

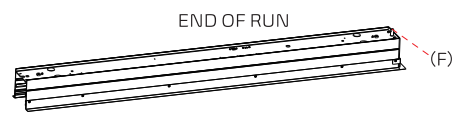
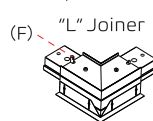
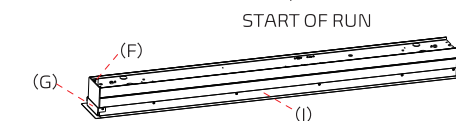

③ Secure the LED modules with aircraft cable and connect the DC male and female terminals

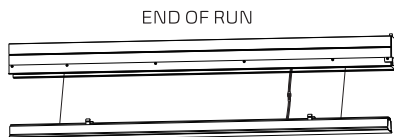
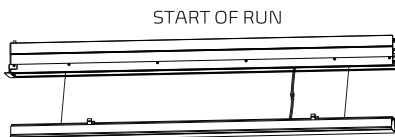

**⚠ RISK OF FIRE AND ELECTRICAL SHOCK. FIXTURE MUST BE INSTALLED BY A QUALIFIED ELECTRICIAN ONLY IN ACCORDANCE WITH NATIONAL, LOCAL BUILDING AND ELECTRICAL CODES. DISCONNECT POWER AT ELECTRICAL PANEL BEFORE SERVICING.**

## DRY CEILING - Trim Drywall (Installed By Recessed Bracket)

### 1 Drill a hole in the ceiling

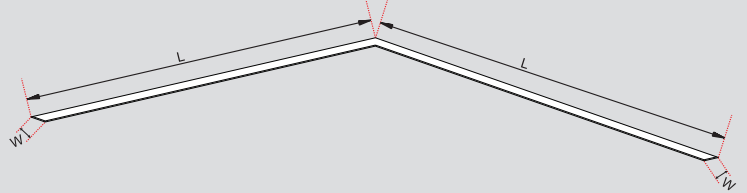

Drill a hole in the ceiling according to the following size:

#### 1. INDIVIDUAL INSTALLATION:

- |   |   |
|---|---|
| ① 2FT: L24.17" X W2.95" (2.3" Width Linear)<br>L24.17" X W4.37" (3.8" Width Linear) | ③ 4FT: L48.19" X W2.95" (2.3" Width Linear)<br>L48.19" X W4.37" (3.8" Width Linear) |
| ② 3FT: L36.18" X W2.95" (2.3" Width Linear)<br>L36.18" X W4.37" (3.8" Width Linear) | ④ 8FT: L95.71" X W2.95" (2.3" Width Linear)<br>L95.71" X W4.37" (3.8" Width Linear) |

#### 2. MULTIPLE LUMINAIRES CONNECTION - LINE :

- |  |  |
|--|--|
| ① 2FT: L24.17" X W2.95" (2.3" Width Linear)<br>L24.17" X W4.37" (3.8" Width Linear)<br>When continuous runs, each additional 2FT fixture, increase the length by 23.51". | ② 3FT: L36.18" X W2.95" (2.3" Width Linear)<br>L36.18" X W4.37" (3.8" Width Linear)<br>When continuous runs, each additional 3FT fixture, increase the length by 35.51". |
| ③ 4FT: L48.19" X W2.95" (2.3" Width Linear)<br>L48.19" X W4.37" (3.8" Width Linear)<br>When continuous runs, each additional 4FT fixture, increase the length by 47.52". | ④ 8FT: L95.71" X W2.95" (2.3" Width Linear)<br>L95.71" X W4.37" (3.8" Width Linear)<br>When continuous runs, each additional 8FT fixture, increase the length by 95.04". |

#### 3. MULTIPLE LUMINAIRES CONNECTION L LINE :

- |  |
|--|
| ① 2FT: L29.45" X W2.95" (2.3" Width Linear)<br>L30.74" X W4.37" (3.8" Width Linear)<br>When continuous runs, each additional 2FT fixture, increase the length by 23.51".   |
| ② 3FT: L41.45" X W2.95" (2.3" Width Linear)<br>L42.75" X W4.37" (3.8" Width Linear)<br>When continuous runs, each additional 3FT fixture, increase the length by 35.51".   |
| ③ 4FT: L53.46" X W2.95" (2.3" Width Linear)<br>L54.76" X W4.37" (3.8" Width Linear)<br>When continuous runs, each additional 4FT fixture, increase the length by 47.52".   |
| ④ 8FT: L100.94" X W2.95" (2.3" Width Linear)<br>L102.28" X W4.37" (3.8" Width Linear)<br>When continuous runs, each additional 8FT fixture, increase the length by 95.04". |

### 2 Fix the recessed bracket to the housing with screws.

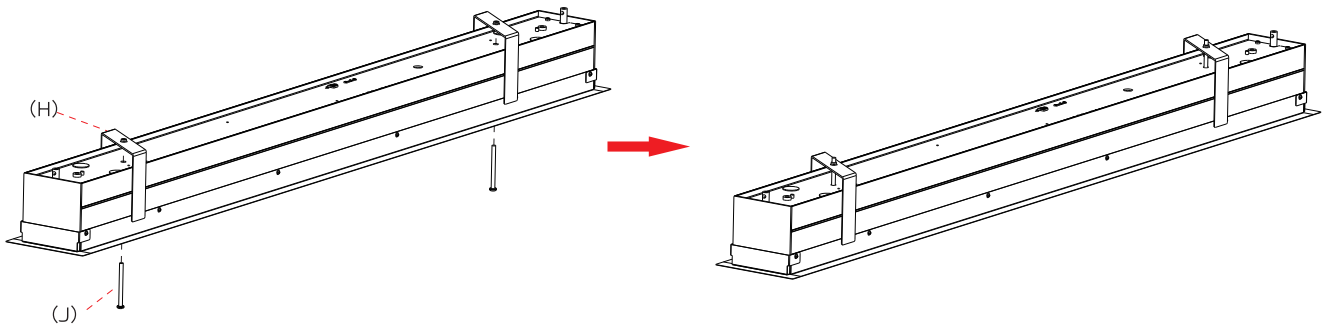

### 3 Secure both ends of the luminaire with safety ropes

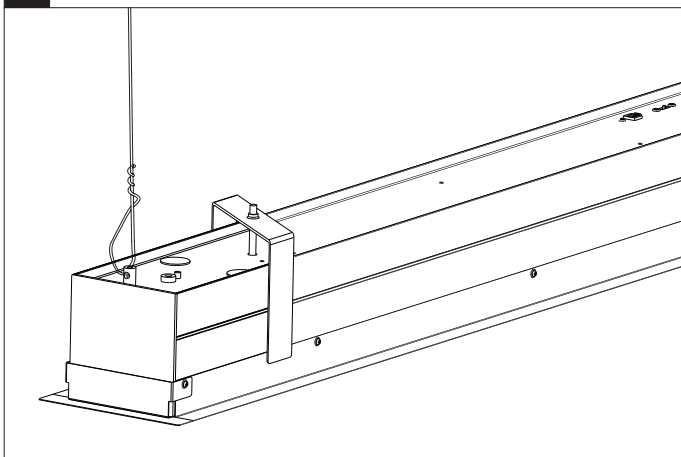

### 4 Wiring

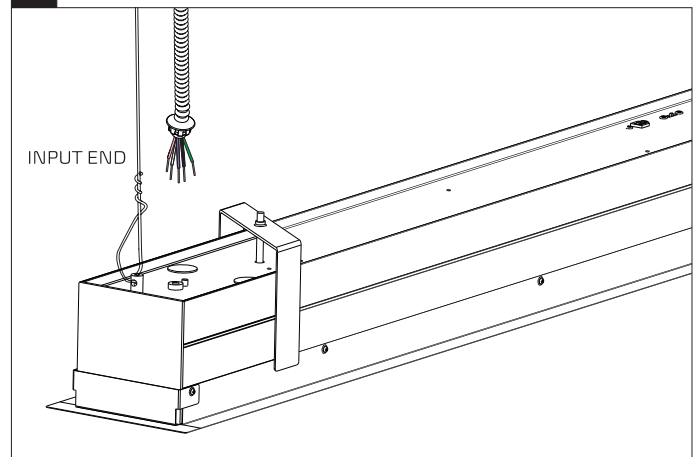

**⚠ RISK OF FIRE AND ELECTRICAL SHOCK. FIXTURE MUST BE INSTALLED BY A QUALIFIED ELECTRICIAN ONLY IN ACCORDANCE WITH NATIONAL, LOCAL BUILDING AND ELECTRICAL CODES. DISCONNECT POWER AT ELECTRICAL PANEL BEFORE SERVICING.**

**5**

Insert the fixture into the ceiling and tighten the screws of recessed brackets to rotate the recessed brackets to fix the fixture on the ceiling.

**6** Refer to steps 6-8 for installation of Multiple Luminaires -LINE Connection

Join and secure luminaire (Middle of run) by Line joiner

**7** Fix the middle fixture to the ceiling using steel wire ropes and recessed brackets.

Repeat Steps 6-7 until the last luminaire (Middle of run) installation is complete

**8**

**Secure the luminaire (End of run):**

1. Slide the whole Line joiner into the last luminaire (Middle of run)
2. Insert the fixture (End of run) into the ceiling
3. Tighten the screws of recessed brackets to rotate the recessed brackets to fix the fixture on the ceiling.
4. Slide the line joiner halfway into the luminaire (End of run) and secure by screws

**9** Refer to steps 9-11 for installation of multiple luminaires L connection.

Connect the housing and L joiner by screws as shown.

**!** RISK OF FIRE AND ELECTRICAL SHOCK. FIXTURE MUST BE INSTALLED BY A QUALIFIED ELECTRICIAN ONLY IN ACCORDANCE WITH NATIONAL, LOCAL BUILDING AND ELECTRICAL CODES. DISCONNECT POWER AT ELECTRICAL PANEL BEFORE SERVICING.

