

STRAIGHT MAGNETIC TRACK LIGHT

Dot Series



The Dot Series is ideal for spot lighting. This design features a deep antiglare spot lens that allows for multiple beam angles, and is available in different wattages and lengths with elegant clean body.

TECHNICAL DATA

Wattage	2W, 4W, 8W, 16W
Input Voltage	24VDC
Beam Angle	12°, 34°, 48°
CCT	2700K, 3000K, 3500K, 4000K
CRI	90
Driver	Triac, 0/1-10V
Certifications	cETL Listed RoHS compliant
Installation	Magnetic
Environment	Indoor



Magnetic Track Profile



Magnetic Track Profile
Recessed with Flange

NOTE:

Straight Magnetic Track Profile sold separately.

ORDERING INFORMATION

EXAMPLE: DOT04-3090-24V-34-MTM-BK

DOT Series	Wattage/Length	CCT&CRI	Voltage	Beam Angle	Installation	Finish
DOT	02 2W/1.34"	2790 2700K/90Ra	24V¹ 24VDC ¹	12 12 degree	MTM Magnetic Track Mount	BK² Black ²
	04 4W/3.3"	3090 3000K/90Ra		34 34 degree		
	08 8W/6.46"	3590 3500K/90Ra		48 48 degree		
	16 16W/12.76"	4090 4000K/90Ra				

NOTE:

1. The fixture is used for 24V magnetic track system.
2. Black and white finish is standard. Custom finish colors are available at an additional charge. Please contact Customer Service for premium options.

DIMENSION

2W

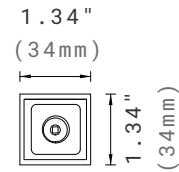
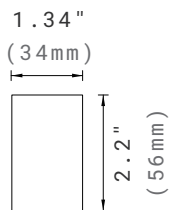
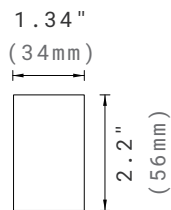

4W

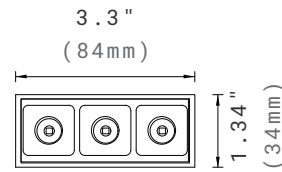
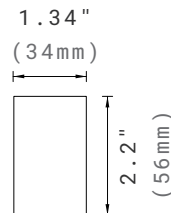
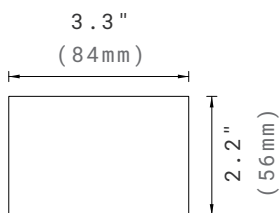

8W

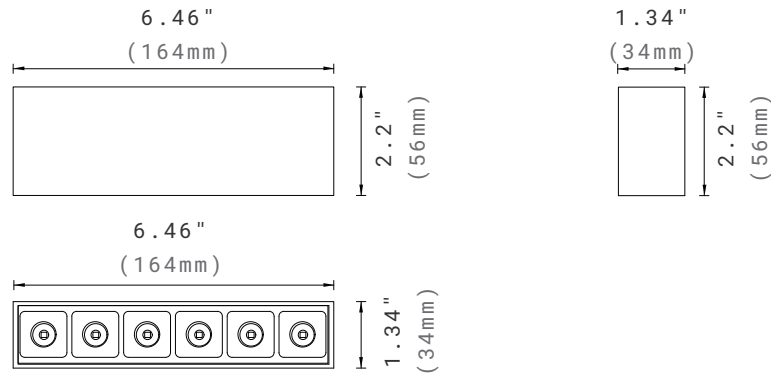
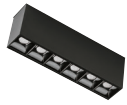

16W

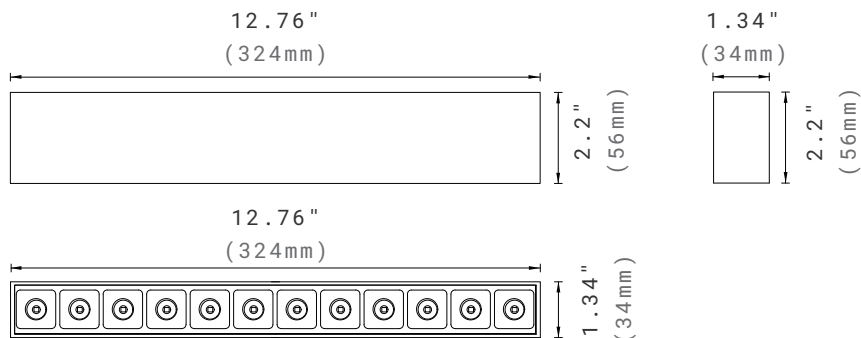

PHOTOMETRY

All published luminaire photometric testing performed to IESNA LM-79-08 standards by a NVLAP certified laboratory. IESNA LM-79-08 specifies the entire luminaire as the source resulting in a fixture efficiency of 100%. Results may vary per actual order.

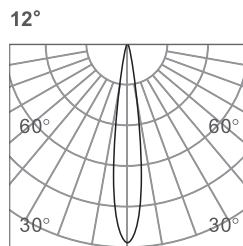

h(m)	E(lx)	Φ(m)
1	3693	Φ0.23
2	923	Φ0.47
3	410	Φ0.71
4	230	Φ0.94
5	147	Φ1.18

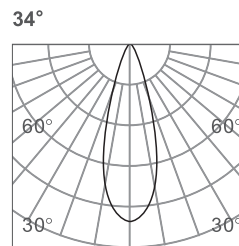

h(m)	E(lx)	Φ(m)
1	1238	Φ0.61
2	309	Φ1.22
3	137	Φ1.83
4	77	Φ2.44
5	49	Φ3.05

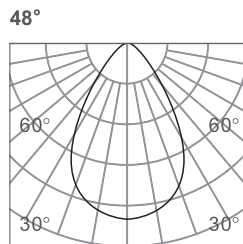

h(m)	E(lx)	Φ(m)
1	778	Φ0.91
2	194	Φ1.82
3	86	Φ2.73
4	48	Φ3.64
5	31	Φ4.55

PERFORMANCE DATA

Lumen values are measured by third party certified laboratories performed in accordance with IESNA LM-79-08 as well as Lighting Facts listed.

Wattage	Lumen Output	CRI	Beam Angle	CCT	LPW
2W	120lm	90	34°	3000K	60
4W	380lm	90	34°	3000K	95
8W	730lm	90	12°/34°/48°	3000K	92
16W	1430lm	90	12°/34°/48°	3000K	89

WARRANTY

5 year limited warranty.

Specifications subject to change without notice.