

2" MAGIC LED LINEAR LIGHT

Wall Wash

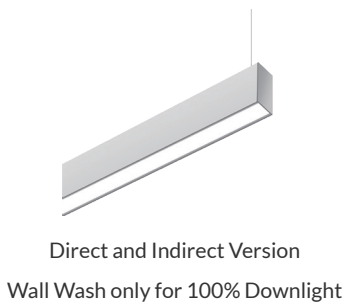
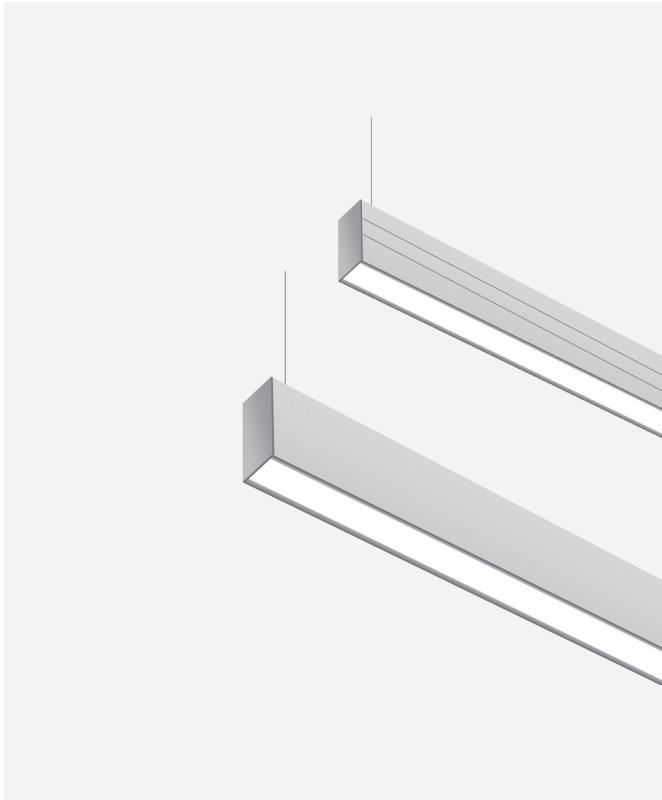

This Magic Wall Wash Linear Light is 30° tilt for accent lighting. 2" wide linear architectural luminaire with a slim and discreet profile. The Magic is available in standard lengths of 2ft, 3ft, 4ft, and 8ft, and can be joined together in seamless runs of desired length. The Magic is an affordable indirect/direct linear LED luminaire.

TECHNICAL DATA

Length/Wattage

| | |
|---------------------|---|
| 2ft | Selectable 10W/15W/20W |
| 3ft | Selectable 15W/20W/30W |
| 4ft | Selectable 20W/30W/40W |
| 8ft | Selectable 40W/60W/80W |
| CRI | 80Ra |
| CCT | Selectable 3000K/3500K/4000K |
| Driver | 1-10V Dimming |
| Compatible Dimmer | LUTRON: DVSTV LEVITON: IP710 |
| Input Voltage | 120-277V, 50/60Hz |
| Operating Temp. | -4°F to 104°F (-20°C to 40°C) |
| Certifications | cULus conforms to UL Std. 1598 Cert. to CSA Std. C22.2 No.250.0 Suitable for damp locations RoHS compliant |
| Power Factor | >0.9 at full load |
| Harmonic Distortion | <20% at full load |
| Projected Lifetime | L70 - 100,000 Hours |

FEATURES

- Wall wash, 30° tilt for accent lighting.
- Comes in lengths of 2ft, 3ft, 4ft, and 8ft.
- Direct and indirect light.
- Seamless continuous runs, up to 42ft.
- CCT and wattage selectable, up to 1200lm/ft.

SPECIFICATION

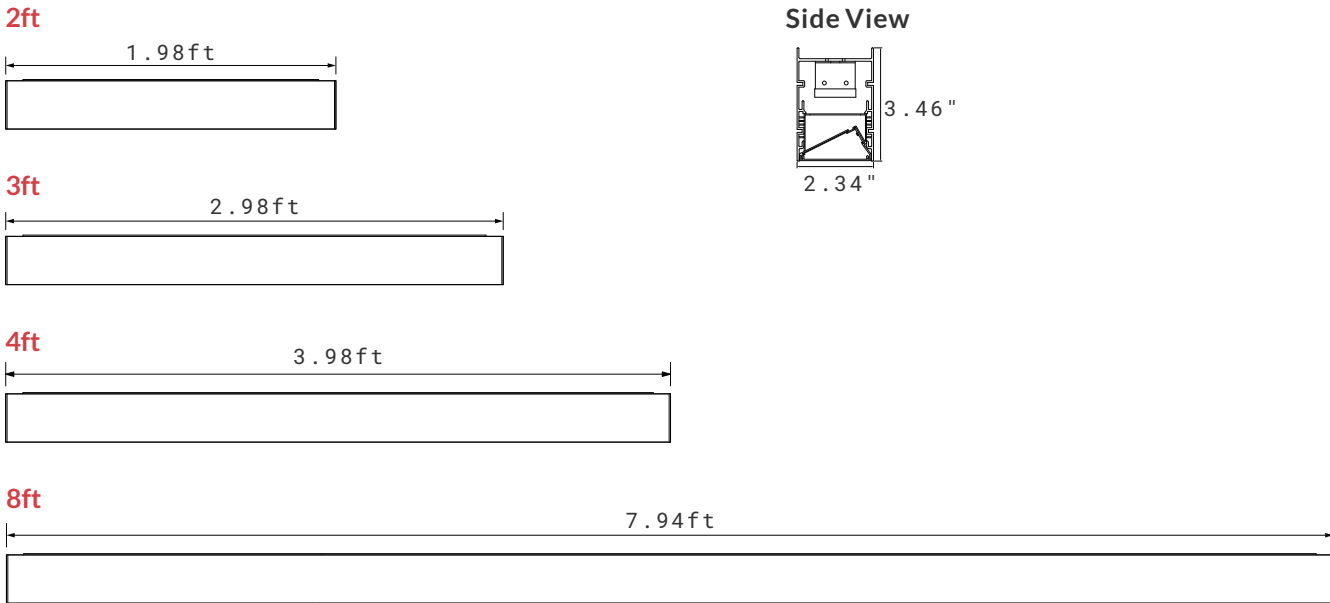

PERFORMANCE DATA

Lumen values are measured by third party certified laboratories performed in accordance with IESNA LM-79-08 as well as Lighting Facts listed.

| Lens | | Flat Lens | Width | Wattage |
|---------------|--------|----------------------|-------|--|
| Lumen Package | High | 1150lm/ft, 10W/ft | 2.3" | 10W/15W/20W@2FT 15W/20W/30W@3FT 20W/30W/40W@4FT 40W/60W/80W@8FT |
| | Medium | 860lm/ft, 7.5W/ft | 2.3" | |
| | Low | 575lm/ft, 5W/ft | 2.3" | |

NOTE:

1. Above are subject to 3500K.
2. All efficacy is ±5% base on different CCT and wattage. Check the IES file to gain the accurate data.

ORDERING INFORMATION

EXAMPLE: MAG1223-SW1-RSM-WD-FDL

| MAG | | | | | |
|-----------|---|---|--|---|----------------------|
| 1. Series | 2. Length | 3. Width | 4. Driver | 5. CCT | 6. Voltage |
| MAG | 06 2ft 09 3ft 12 4ft 24 8ft Option¹ Desired System Length | 23 2.3 Inch | BLANK Integral 1-10V Dimming | SW² Selectable 3000K 3500K 4000K ² | 1 120-277V |
| | 7. Mounting Options | 8. Light Distribution | 9. Lens Options | 10. Finish | |
| | PSM Suspended and Surface Mounted. <i>PSM is for direct and indirect version (WID) only</i> RSM Recessed, Suspended and Surface Mount <i>RSM is for direct version (WD) only</i> WM Wall Mounted <i>WM is for both WID and WD versions</i> | WID⁴ Direct and Indirect Version Wall Wash only for 100% Downlight ⁴ <i>Following options available by dip switch</i> 100% Uplight 10% Down, 90% Up 30% Down, 70% Up 50% Down, 50% Up 70% Down, 30% Up 90% Down, 10% Up 100% Downlight ³ WD⁵ Wall Wash Direct Version ⁵ | FDL⁶ Flush Diffused Lens ⁶ | BLANK White BK Black | |

ORDERING INFORMATION

NOTE:

1. Individual fixtures, runs and configurations are supplied in nominal lengths to ensure full, even, illumination. If desired runs and configurations are needed, please tell us the details in advance. Then we can prepare the middle run and end run in factory for easy installation, or end user need to modify the standard individual fixtures into middle run and end run.
2. The default CCT setting is 4000K.
3. Default setting is 100% downlight.
4. Available in suspended, surface mount and wall mount. Wall mount can be reversed.
5. Available in recessed, suspended, surface mount and wall mount. Wall mount can be reversed.
6. If the joined length exceeds 8ft, only continuous Roll-Out Lens can be used.

ACCESSORIES (ORDERED SEPARATELY AND FIELD INSTALLED)

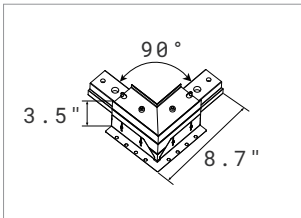

MAG23-RSM-L
L Shape Mount Bracket
for Recessed, Suspended
and Surface Mount.

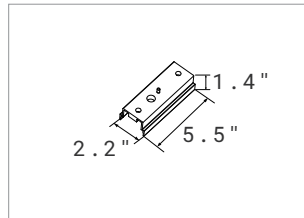

MAG23-RSM-LINE
Line Shape Mount Bracket
for Recessed, Suspended
and Surface Mount.



MAG23-ROL¹
Continuous Roll-Out Lens
(42ft).¹



MAG-MSW-PM/SM
Microwave Motion Sensor
Kit for Pendant Mount.

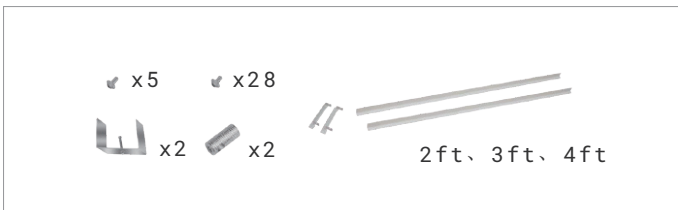

Dry Ceiling Recessed, Trim+Recessed with Bracket

MAG0623-RMK-DY-TM-BKT
Trim Recessed with Bracket 2ft, 2" Linear.

MAG0923-RMK-DY-TM-BKT
Trim Recessed with Bracket 3ft, 2" Linear.

MAG1223-RMK-DY-TM-BKT
Trim Recessed with Bracket 4ft, 2" Linear.

2 sets of **MAG1223-RMK-DY-TM-BKT** are required for 8ft runs.

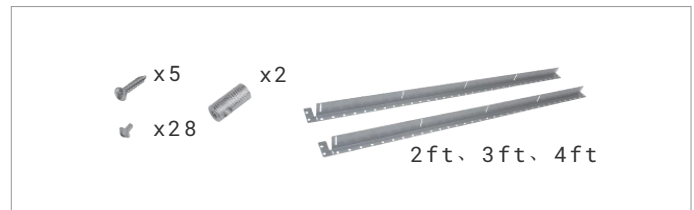

Dry Ceiling Recessed, Trimless

MAG0623/38-RMK-DY-TMS
Trimless Recessed 2ft, 2"/4" Linear.

MAG0923/38-RMK-DY-TMS
Trimless Recessed 3ft, 2"/4" Linear.

MAG1223/38-RMK-DY-TMS
Trimless Recessed 4ft, 2"/4" Linear.

2 sets of **MAG1223/38-RMK-DY-TMS** are required for 8ft runs.

ACCESSORIES (ORDERED SEPARATELY AND FIELD INSTALLED)

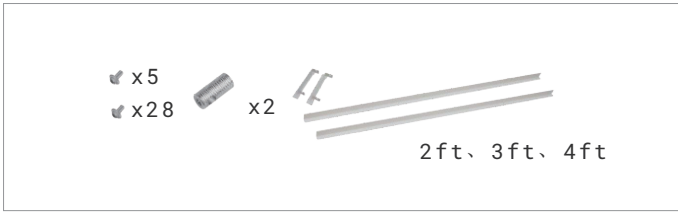

Dry or Drop Ceiling Recessed, Trim+Recessed with Pendant Stem

MAG0623/38-RMK-DY/DP-TM-STEM

Trim Recessed with Pendant Stem 2ft, 2"/4" Linear.

MAG0923/38-RMK-DY/DP-TM-STEM

Trim Recessed with Pendant Stem 3ft, 2"/4" Linear.

MAG1223/38-RMK-DY/DP-TM-STEM

Trim Recessed with Pendant Stem 4ft, 2"/4" Linear.

2 sets of **MAG1223/38-RMK-DY/DP-TM-STEM** are required for 8ft runs.

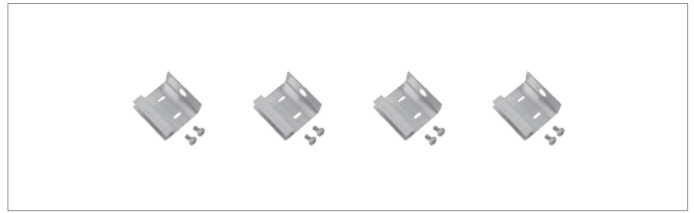

Drop Ceiling Recessed, Trimless+T-grid Hooks.

MAG23/38-RMK-DP-TMS

T-grid Recessed Kits for 2"/4" Magic Linear.

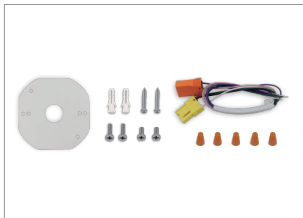

MAG-SMK

Surface and Wall Mount Kits.



AAL-RC-100

Remote Control for Microwave Motion Sensor.



AAL-EBU-AC08D-YYY²

Remote 8W LED
Emergency Battery
Back-up 120-347VAC.

AAL-EBU-AC25D-YYY²

Remote 25W LED
Emergency Battery
Back-up 120-347VAC.



ACGP

Aircraft Cable Gripper
(a pair)
Suitable for Ø 0.06"-0.08"
Aircraft Cable including
two pieces.

NOTE:

1. If the joined length exceeds 8ft, only continuous Roll-Out Lens can be used.
2. The 8W EBU supports up to 60W total lighting load. The 25W EBU supports up to 150W total lighting load. The dimming control wire must be connected. Emergency battery backup operates within ambient temperatures of 32°F to 95°F (0°C to 35°C).

ACCESSORIES (ORDERED SEPARATELY AND FIELD INSTALLED)



Drop Ceiling Suspension Mount List.¹

MAG-PMK3-5FT

Aircraft Cable Pendant Mount Kits for Drop Ceiling, with 5ft aircraft cable and 5ft power cord (One set per fixture).

MAG-PMK3-12FT

Aircraft Cable Pendant Mount Kits for Drop Ceiling, with 12ft aircraft cable and 12ft power cord (One set per fixture).

NOTE:

1. Suitable for 9/16" and 15/16" Flat Ceiling. If for 9/16" Slot Ceiling please contact Customer Service.

Dry Ceiling Suspension Mount List.

MAG-PMK1-5FT

Aircraft Cable Pendant Mount Kits for Dry Ceiling, with 5ft aircraft cable and 5ft power cord (One set per fixture).

MAG-PMK1-12FT

Aircraft Cable Pendant Mount Kits for Dry Ceiling, with 12ft aircraft cable and 12ft power cord (One set per fixture).

MOUNTING LOCATION

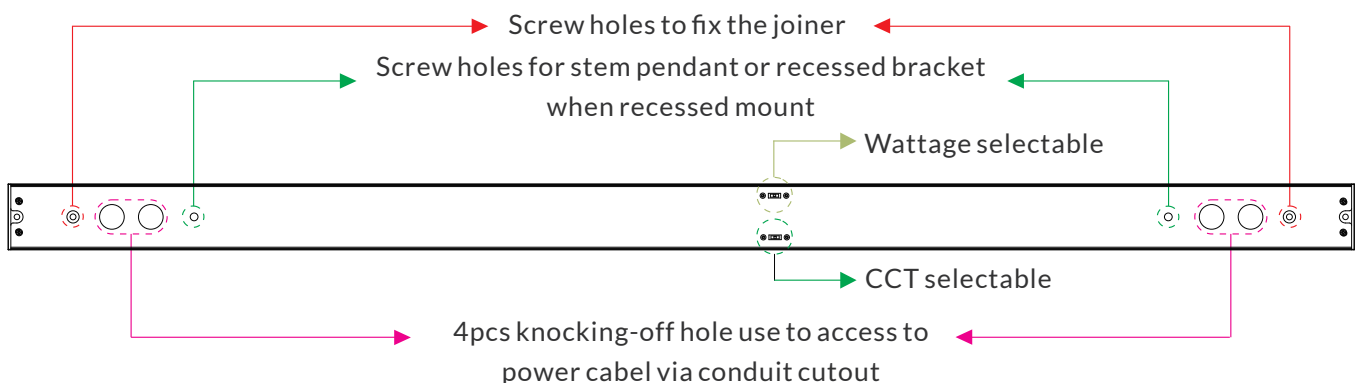

PHOTOMETRY

All published luminaire photometric testing performed to IESNA LM-79-08 standards by a NVLAP certified laboratory. IESNA LM-79-08 specifies the entire luminaire as the source resulting in a fixture efficiency of 100%. Results may vary per actual order.

100% Direct

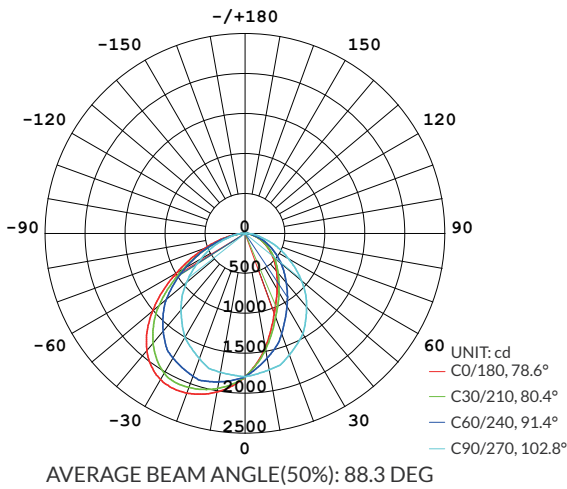

10% Indirect and 90% Direct

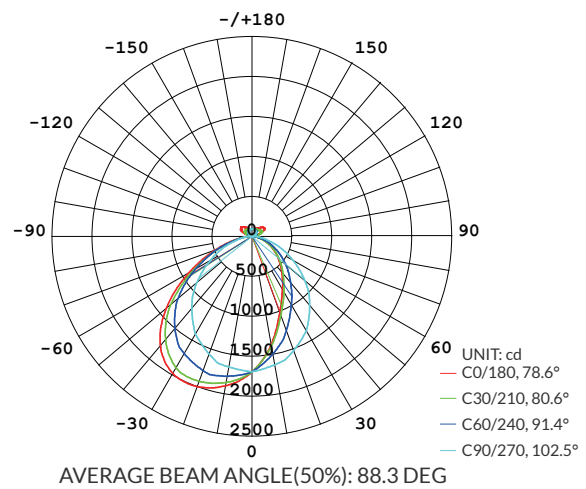

30% Indirect and 70% Direct

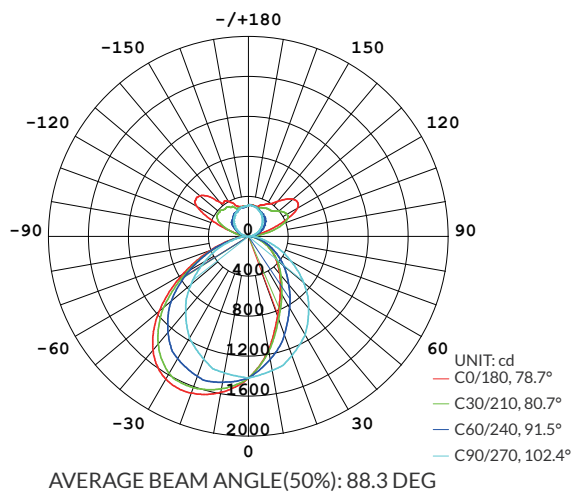

50% Indirect and 50% Direct

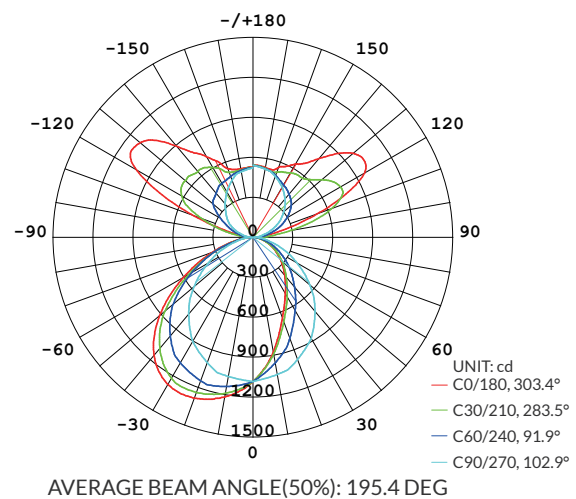

PHOTOMETRY

70% Indirect and 30% Direct

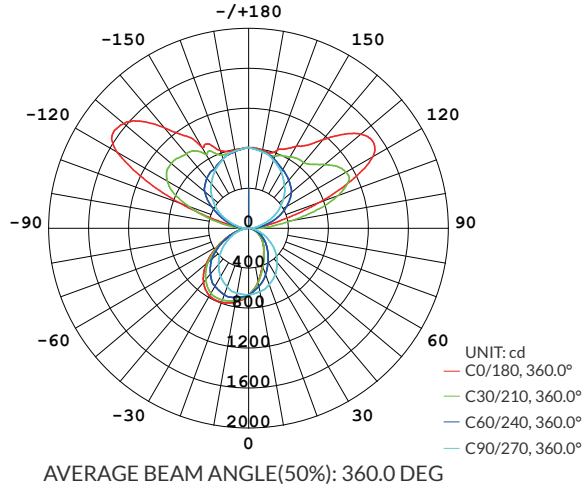

90% Indirect and 10% Direct

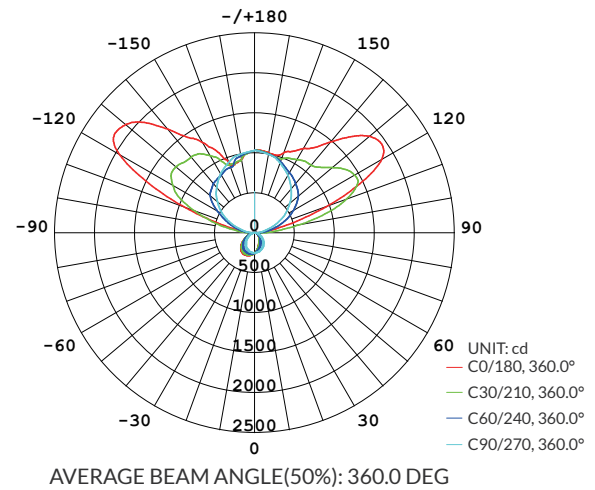

100% Indirect

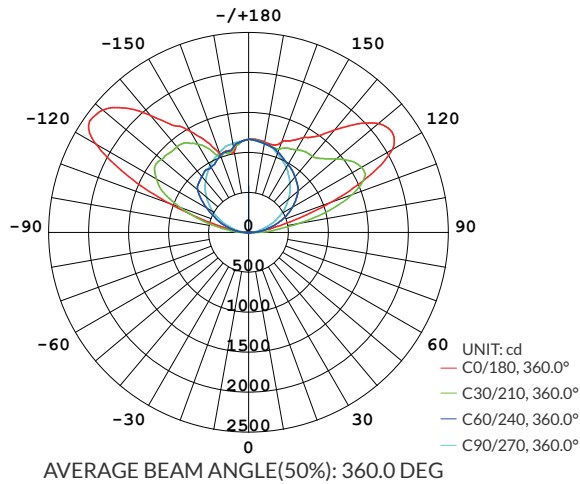

18"-30" Recommended Distance from Wall

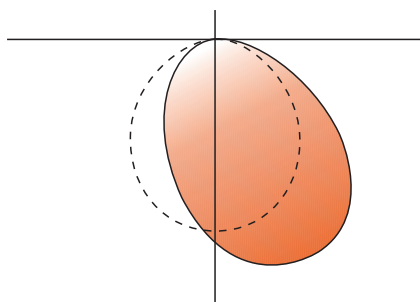

Pendant



Surface

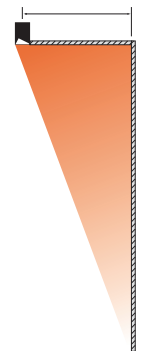

Recessed

MICROWAVE DIMMING SENSOR SETTING (120-277V)

3-step dimming function

The sensor is an innovative motion sensor, switch on the light on detection of movement, and switch off after a hold time when there is no motion detected.



1. No motion detected, all lamps switch off.

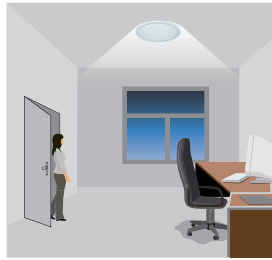

2. Any movement is detected from any direction, all lamps synchronously switch on.

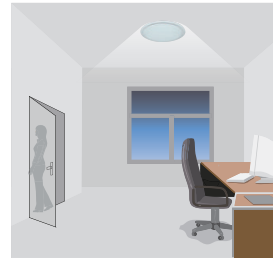

3. No motion is detected in detection area, all lamps synchronously dim to a low light level after hold time.



4. After stand-by period, the lamps switch off if no movement is detected in the detection zone.

MICROWAVE DIMMING SENSOR SETTING (120-277V)

By selecting the combination on the DIP switch, sensor data can be precisely set for each specific application. The sensor setting also can be done by a remote control (RC-100) which need to be bought separately.

| | 1 | 2 | |
|-----|---|---|------|
| I | ↓ | ↓ | 20% |
| II | ↓ | ↑ | 50% |
| III | ↑ | ↓ | 75% |
| IV | ↑ | ↑ | 100% |

Sensitivity

Sensitivity can be reduced by selecting the combination on the DIP switches to fit precisely each application.

Default Setting: 100%

| | 3 | 4 | |
|-----|---|---|--------|
| I | ↓ | ↓ | 10s |
| II | ↓ | ↑ | 1min |
| III | ↑ | ↓ | 5mins |
| IV | ↑ | ↑ | 15mins |

Hold time

Refers to the time period the lamp remains at 100% illumination after no motion detected.

Default Setting: 15mins

| | 5 | 6 | |
|-----|---|---|--------|
| I | ↓ | ↓ | ☀ |
| II | ↓ | ↑ | 10 lux |
| III | ↑ | ↓ | 30 lux |
| IV | ↑ | ↑ | 50 lux |

Daylight sensor

The sensor can be set to only allow the lamp to illuminate below a defined ambient brightness threshold.

Default Setting: ☀ (Disable)

| | 7 | 8 | |
|-----|---|---|-----|
| I | ↓ | ↓ | 0% |
| II | ↓ | ↑ | 10% |
| III | ↑ | ↓ | 30% |
| IV | ↑ | ↑ | 50% |

Stand-by dimming level

The low light level you would like to have after the hold time in the long absence of people.

Default Setting: 50%

MICROWAVE DIMMING SENSOR SETTING (120-277V)

| | 9 | 10 | |
|-----|---|----|--------|
| I | ↓ | ↓ | +∞ |
| II | ↓ | ↑ | 1min |
| III | ↑ | ↓ | 30mins |
| IV | ↑ | ↑ | 60mins |

Stand-by time

Refers to the time period the lamp remains at a low light level before it completely switches off in the long absence of people. When set to “ +∞ ” mode, the low light is maintained until motion is detected.

Default Setting: 30mins

WARRANTY

5 years limited warranty.

Specifications subject to change without notice.

Ref#: 20250616